

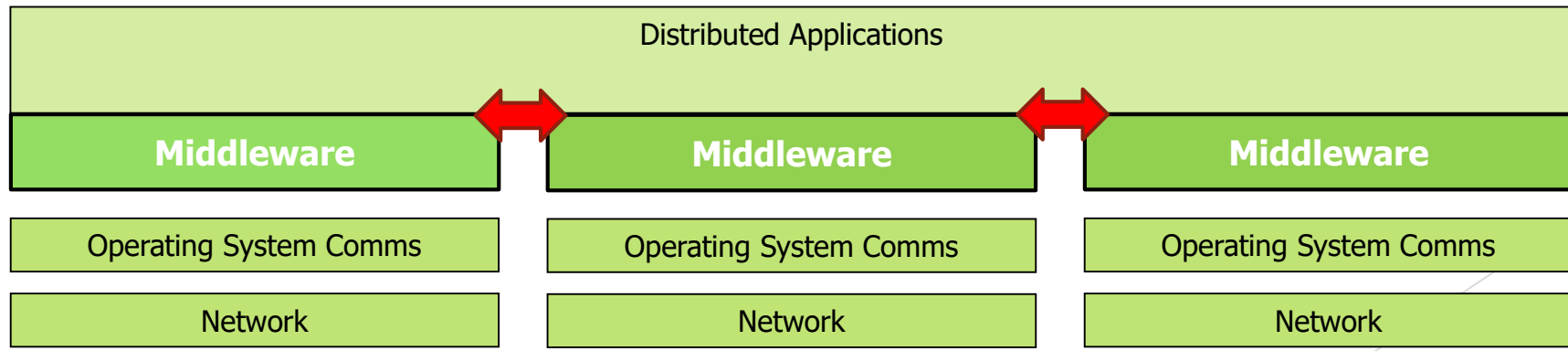

Middleware and Communication Patterns



Classical Communication Patterns for middleware : a first characteristic

- ▶ They are :
 - ▶ Remote procedure call
 - ▶ Object oriented middleware
 - ▶ Message oriented middleware
 - ▶ Event based middleware and complex event processing

(1) Remote Procedure Call (RPC)

- ▶ Masks remote function calls as being local
- ▶ Client/server model
- ▶ Request/reply paradigm usually implemented with message passing in RPC service
- ▶ Marshalling of function parameters and return value

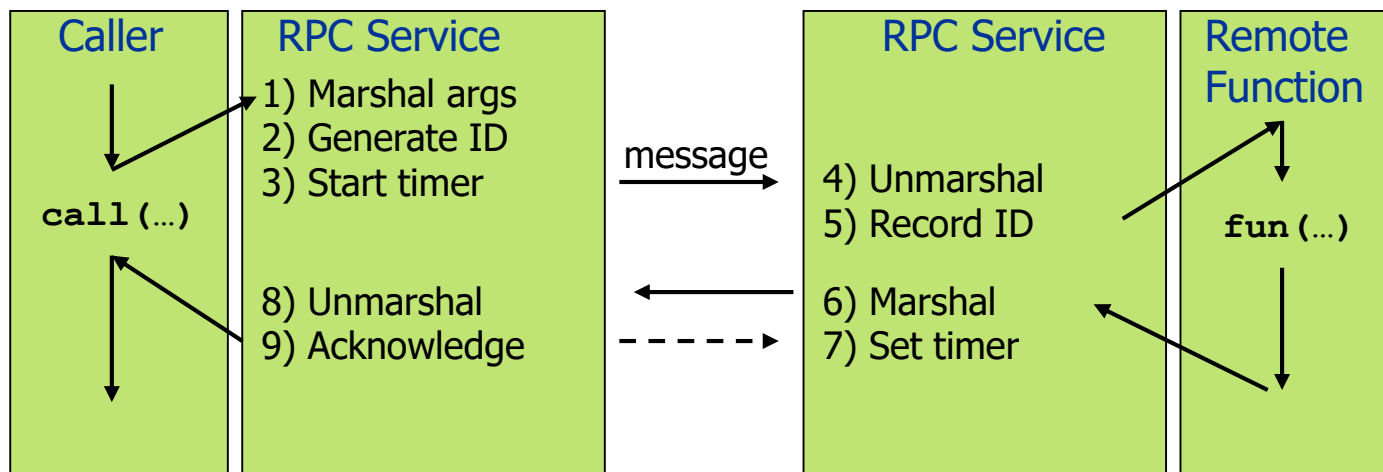

Properties of RPC

- ▶ Language-level pattern of function call
 - ▶ easy to understand for programmer
- ▶ Synchronous request/reply interaction
 - ▶ natural from a programming language point-of-view
 - ▶ matches replies to requests
 - ▶ built in synchronisation of requests and replies
- ▶ Distribution transparency (in the no-failure case)
 - ▶ hides the complexity of a distributed system

Disadvantages and limitations of RPC

- ▶ Synchronous request/reply interaction
 - ▶ tight coupling between client and server
 - ▶ client may block for a long time if server loaded
 - ▶ leads to multi-threaded programming in client
 - ▶ slow/failed clients may delay servers when replying
 - ▶ multi-threading essential for servers
- ▶ Distribution Transparency
 - ▶ Not possible to mask all problems
- ▶ RPC paradigm is not object-oriented
 - ▶ invoke functions on servers as opposed to methods on objects

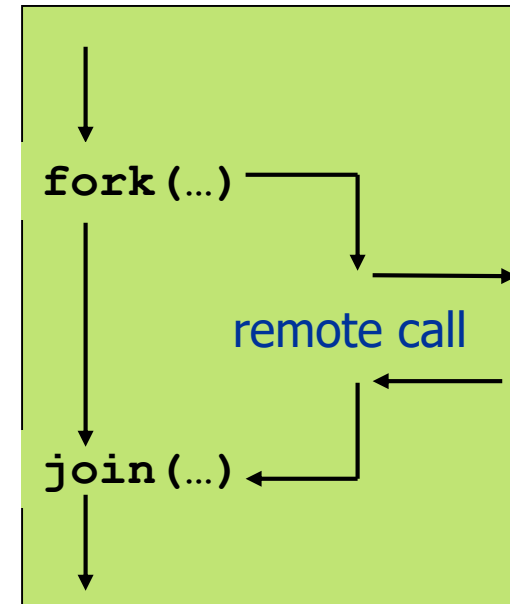

Do you know ?

- ▶ Any example for RPC based Middleware ?
- ▶ in your background ...

- ▶ Example :
 - ▶ See XML-RPC : <http://www.tutorialspoint.com/xml-rpc/>
 - ▶ One kind of Web Service Middleware Communication paradigm is RPC
 - ▶ See W3C consortium : <http://www.w3schools.com/webservices/>

(2) Object-Oriented Middleware (OOM)

- ▶ Objects can be local or remote
- ▶ Object references can be local or remote
- ▶ Remote objects have visible remote interfaces
- ▶ Masks remote objects as being local using proxy objects
- ▶ Remote method invocation

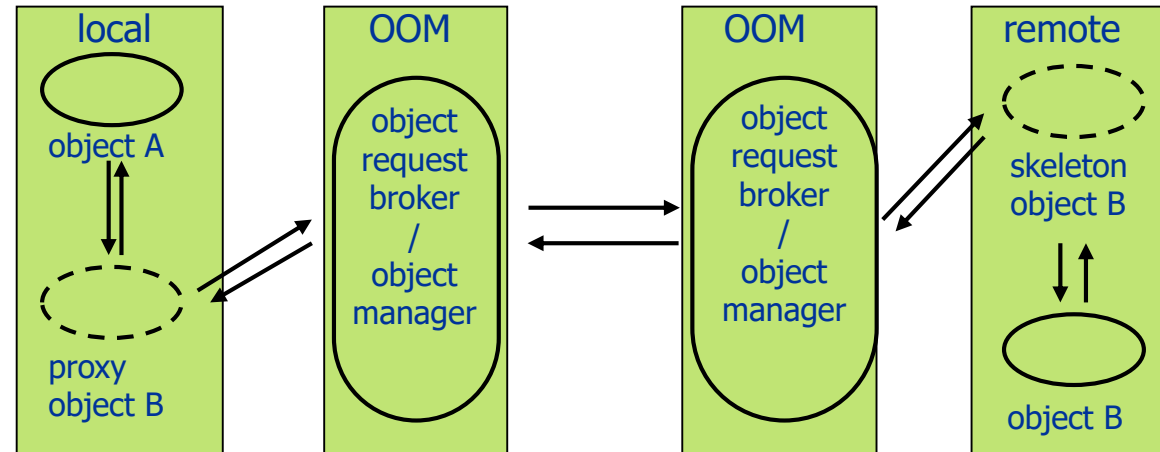

Properties of OOM

- ▶ Support for object-oriented programming model
 - ▶ objects, methods, interfaces, encapsulation, ...
 - ▶ exceptions (were also in some RPC systems)
- ▶ Synchronous request/reply interaction
 - ▶ same as RPC
- ▶ Location Transparency
 - ▶ system (ORB) maps object references to locations

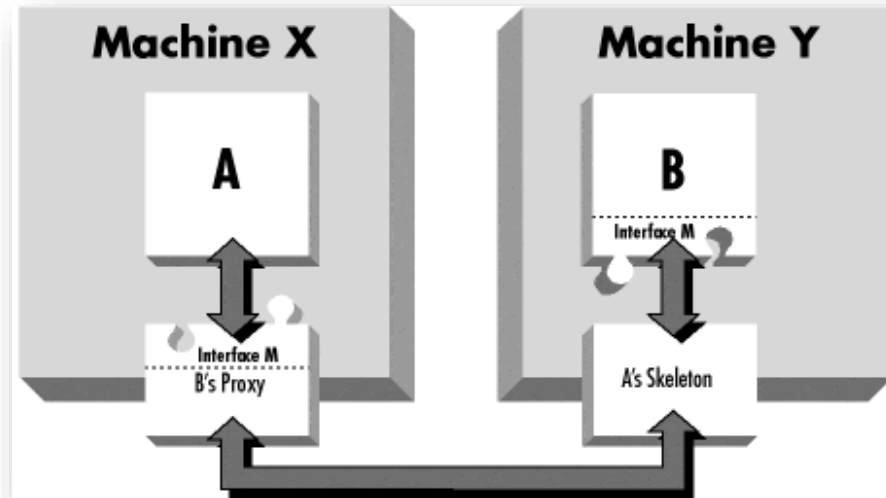

Do you know ?

- ▶ Any example for OOM ?
- ▶ in your background ...
- ▶ Examples ...

Java Remote Method Invocation (RMI)

- ▶ Covered in Java programming
- ▶ Distributed objects in Java

```
public interface PrintService extends Remote {  
    int print(Vector printJob) throws RemoteException;  
}
```

- RMI compiler creates proxies and skeletons
- RMI registry used for interface lookup
- Entire system written in Java (single-language system)

CORBA

- ▶ Common Object Request Broker Architecture
 - ▶ Open standard by the OMG (Version 3.0)
 - ▶ Language and platform independent

- **Object Request Broker (ORB)**
 - General Inter-ORB Protocol (GIOP) for communication
 - Interoperable Object References (IOR) **contain object location**
 - CORBA **Interface Definition Language (IDL)**
 - Stubs (proxies) and skeletons created by IDL compiler

CORBA IDL

- ▶ Definition of language-independent remote interfaces
 - ▶ Language mappings to C++, Java, Smalltalk, ...
 - ▶ Translation by IDL compiler
- ▶ Type system
 - ▶ basic types: long (32 bit), long long (64 bit), short, float, char, boolean, octet, any, ...
 - ▶ constructed types: struct, union, sequence, array, enum
 - ▶ objects (common super type Object)
- ▶ Parameter passing
 - ▶ in, out, inout
 - ▶ basic & constructed types passed by value
 - ▶ objects passed by reference

```
typedef sequence<string> Files;  
interface PrintService : Server {  
    void print(in Files printJob);  
};
```

Advantages and Disadvantages of OOM

- ▶ Totally transparent distributed programming
- ▶ Synchronous request/reply interaction only
 - ▶ So CORBA oneway semantics added Asynchronous Method Invocation (AMI)
 - ▶ But implementations may not be loosely coupled
- ▶ Distributed garbage collection
 - ▶ Releasing memory for unused remote objects
- ▶ OOM rather static and heavy-weight
 - ▶ Unadapted for ubiquitous systems and embedded devices

(3) Message-Oriented Middleware (MOM)

- ▶ Communication using messages
- ▶ Messages stored in message queues
- ▶ message servers decouple client and server
- ▶ Various assumptions about message content

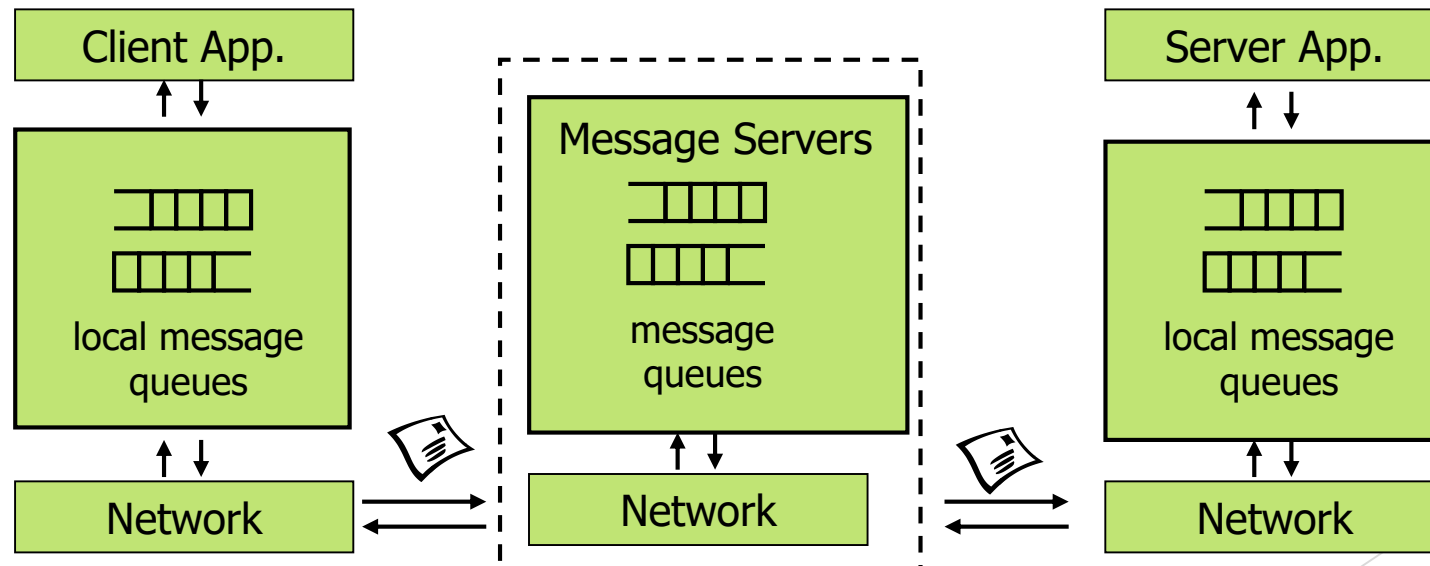

Properties of MOM

- ▶ Asynchronous interaction
 - ▶ Client and server are only loosely coupled
 - ▶ Messages are queued
 - ▶ Good for application integration
- ▶ Processing of messages by intermediate message server(s)
 - ▶ May do filtering, transforming, logging, ...
 - ▶ Networks of message servers

Java Message Service (JMS)

- ▶ API specification to access MOM implementations
- ▶ Two modes of operation *specified*:
 - ▶ Point-to-point
 - ▶ one-to-one communication using queues
 - ▶ Publish/Subscribe
 - ▶ cf. One pattern for Event-Based Middleware (ex . Java)
- ▶ JMS Server implements JMS API
- ▶ JMS Clients connect to JMS servers
- ▶ Java objects can be serialised to JMS messages

Disadvantages of MOM

- ▶ Poor programming abstraction (but has evolved)
 - ▶ Rather low-level (cf. Packets)
 - ▶ Request/reply more difficult to achieve, but can be done
- ▶ Message formats originally unknown to middleware
 - ▶ No type checking (JMS addresses this - implementation?)
- ▶ Queue abstraction only gives one-to-one communication
 - ▶ Limits scalability (JMS pub/sub - heavy implementation of event based communications)

(4) Event-Based Middleware

- ▶ 1 emitter - N receiver
- ▶ With broadcast communications (ex. UDP)
- ▶ With unicast communications or peer to peer (ex. TCP), multiple communications are required

(4) Event-Based Middleware, ex. Publish/Subscribe Pattern

- ▶ Publishers (advertise and) publish events (messages)
- ▶ Subscribers express interest in events with subscriptions
- ▶ Event Service notifies interested subscribers of published events
- ▶ Events can have arbitrary content (typed) and name/value pairs

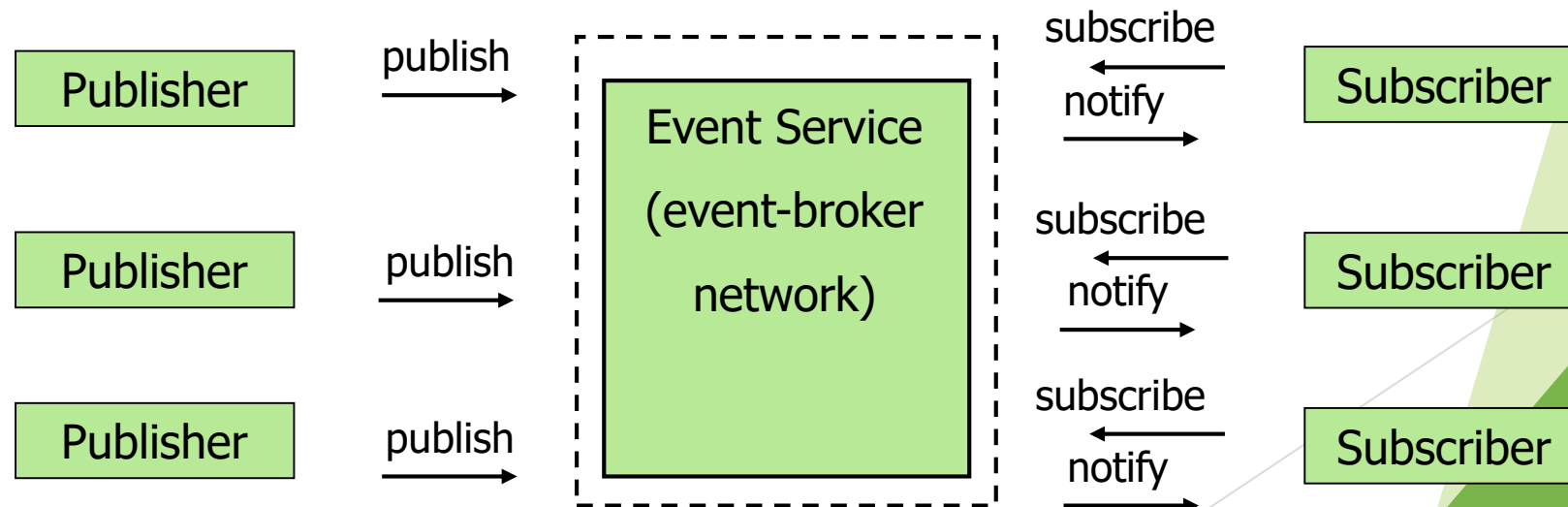

Properties of Publish/Subscribe

- ▶ Asynchronous communication
 - ▶ Publishers and subscribers are loosely coupled
- ▶ Many-to-many interaction between pubs. and subs.
 - ▶ Scalable scheme for large-scale systems
 - ▶ Publishers do not need to know subscribers, and vice-versa
 - ▶ Dynamic join and leave of pubs, subs
- ▶ (Topic and) Content-based pub/sub very expressive
 - ▶ Filtered information delivered only to interested parties

Complex event Processing (CEP)

- ▶ Composite Event Processing (CEP)

- ▶ Events produce events after processing

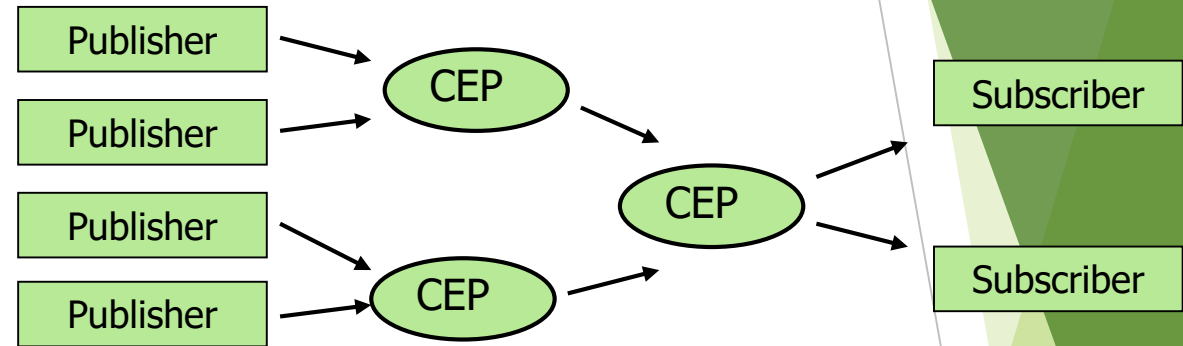

- ▶ Example of CEP : Composite Event Detection (CED)

- ▶ Content-based pub/sub may not be expressive enough

- ▶ Potentially thousands of event types (primitive events)
- ▶ Subscribers interest: event patterns

- ▶ Composite Event Detectors (CED)

- ▶ Subscribe to primitive events and publish composite events

- ▶ Alternative Implementation ... (need multicast communications)

Summary

1. Remote Procedure Call
2. Object-Oriented Middleware
3. Message-Oriented Middleware
4. Event-Based Middleware

Example : Next
MQTT Tutorial

- ▶ Middleware is an important abstraction for building distributed systems
- ▶ Synchronous vs. asynchronous communication
- ▶ Scalability, many-to-many communication
- ▶ Language integration
- ▶ Ubiquitous systems, mobile systems