

Next Step

- ➔ **1. Infrastructure** : based on Web services for Device
- ➔ **2. Composition** : based on CBSE
- 3. Self-Adaptation**

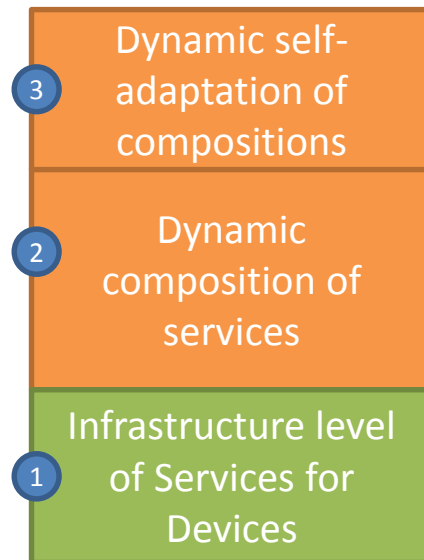

Web Services for Devices Infrastructure

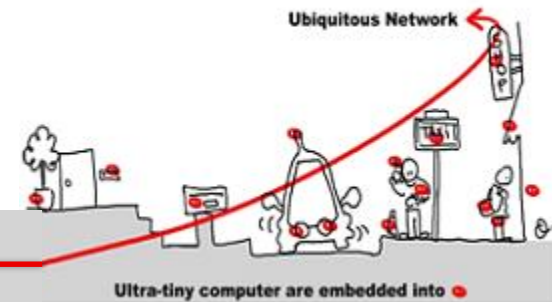

- Requirements for WComp Infrastructure
 - New ways of interacting: Eventing

Decentralized and Contextual discovery
Managing Appearance and Disappearance
Eventing

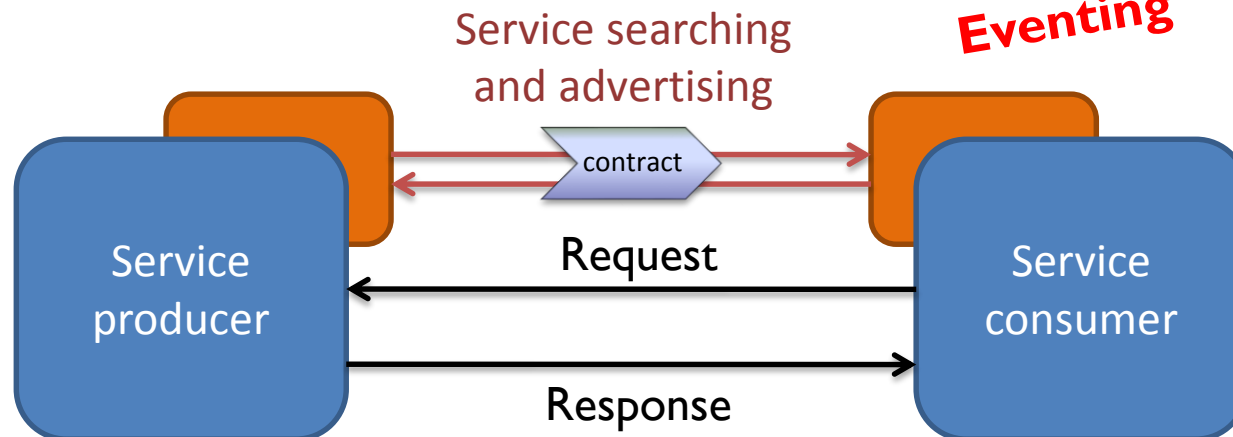

LCA model

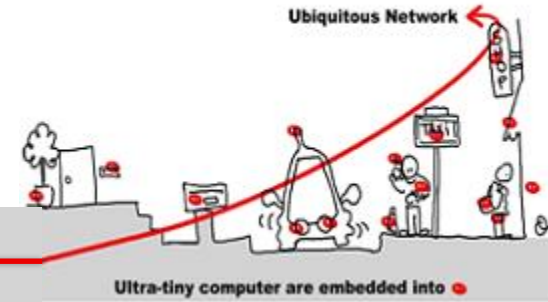

- LCA components

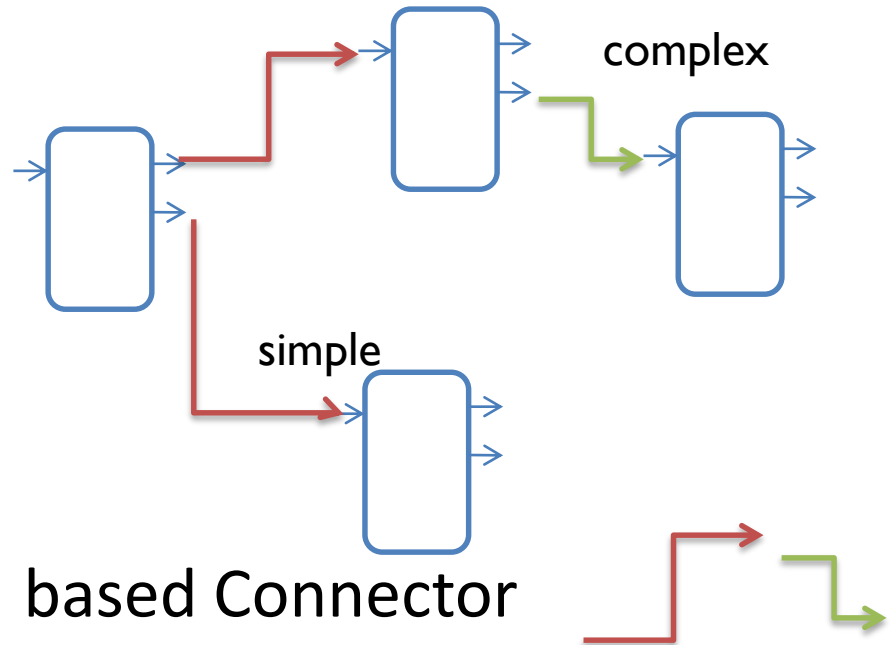
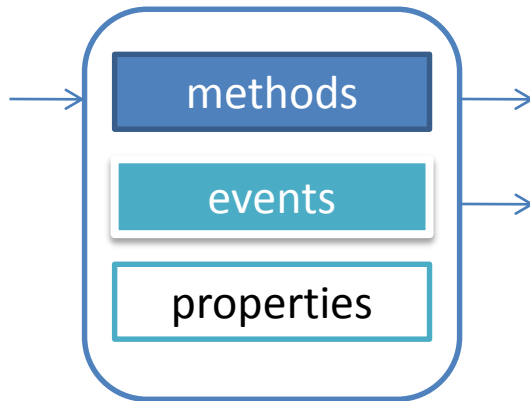

- Simple and complex Event based Connector

- Proxy Components

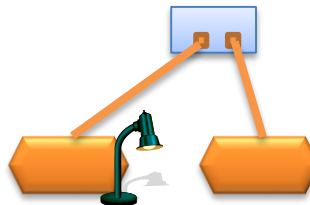

SLCA Model : Composite Service

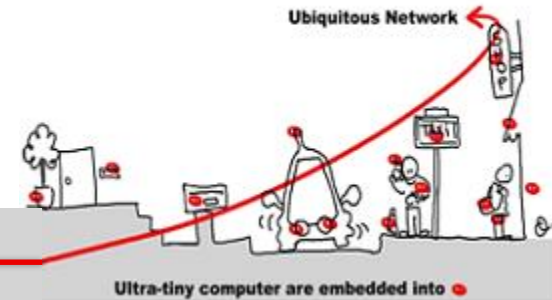

- New components as Probe components

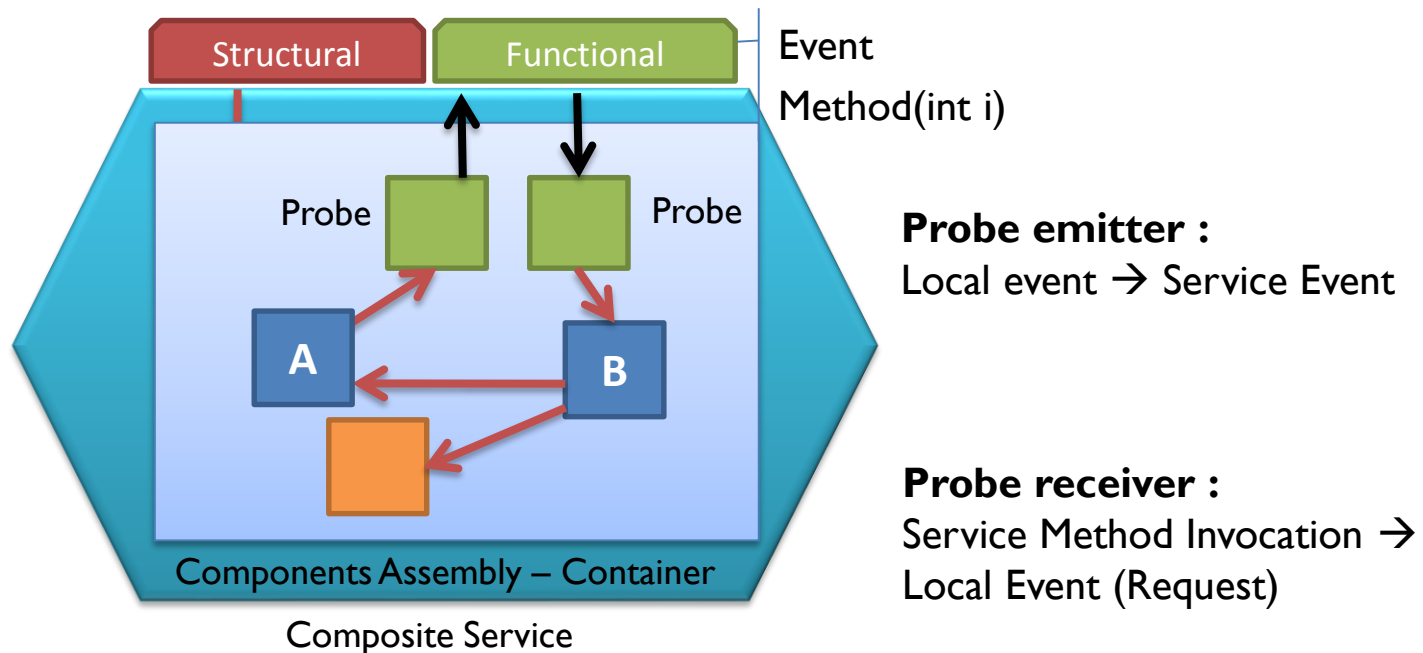

- Two interfaces : structural and functional

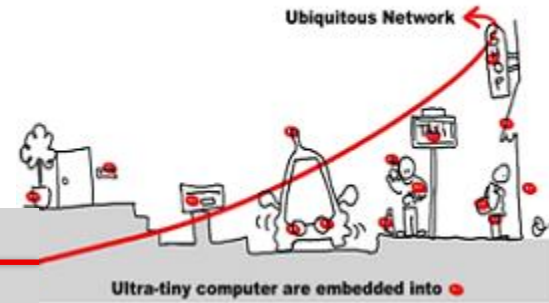

First Part of the Pratical Course

Dynamic Composite Services

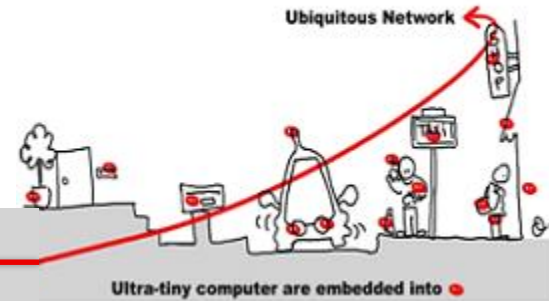

Self Adaptive Middleware for Ubiquitous Computing : Lecture 6

Jean-Yves Tigli

University of Nice – Sophia Antipolis / Polytech'Nice -
Sophia

Members of the RAINBOW research team (I3S)

Challenge 1 : Real world interaction

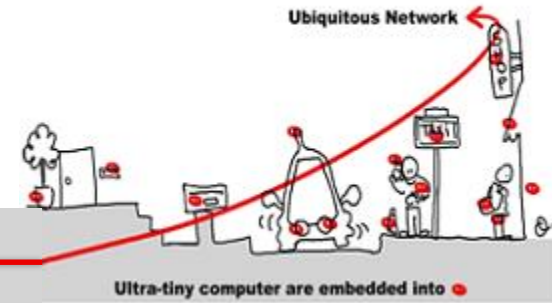

- Ubiquitous Computing applications are continuously interacting with a **real world, partly unknown** at design time and, **always changing** at runtime in **uncountable manner**
- We witness to a kind of **inversion in the classical software methodology** where the software applications levels are much more stable and stationary than the software infrastructure level.

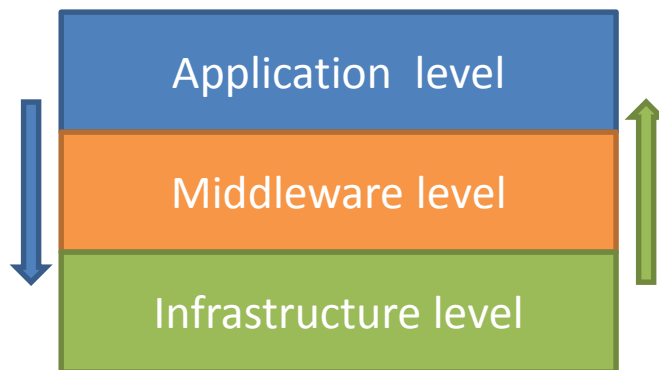

Challenge 2 : Multi-Domain Adaptation

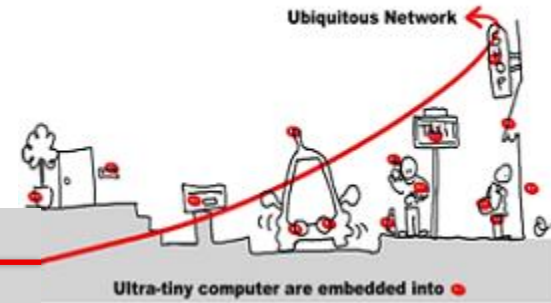

- Ubiquitous Middleware must continuously adapt at runtime, application requirements to changing computing environment (due to mobility) in multiple domains :
 - HMI,
 - Power,
 - Network bandwidth,
 - Devices availability, ...



Challenge 3 : Reactive Adaptation

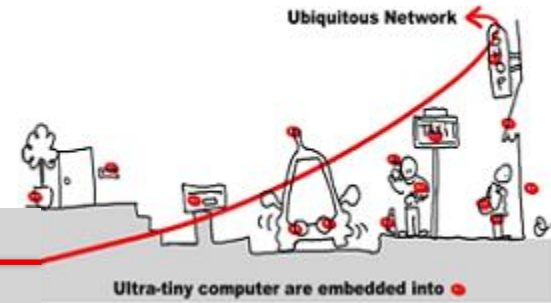

- Reactive adaptation is defined as the ability for the Ubiquitous applications to perceive the environment and adapt to changes in that environment in a timely fashion.
- Ubiquitous Middleware must provide reactive adaptation mechanism to changing operational environment.



Challenge 4 : Semantic Adaptation

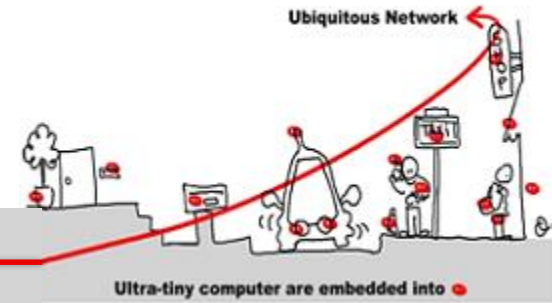

- Ubiquitous Middleware must match at runtime the current operational environment and application requirements.

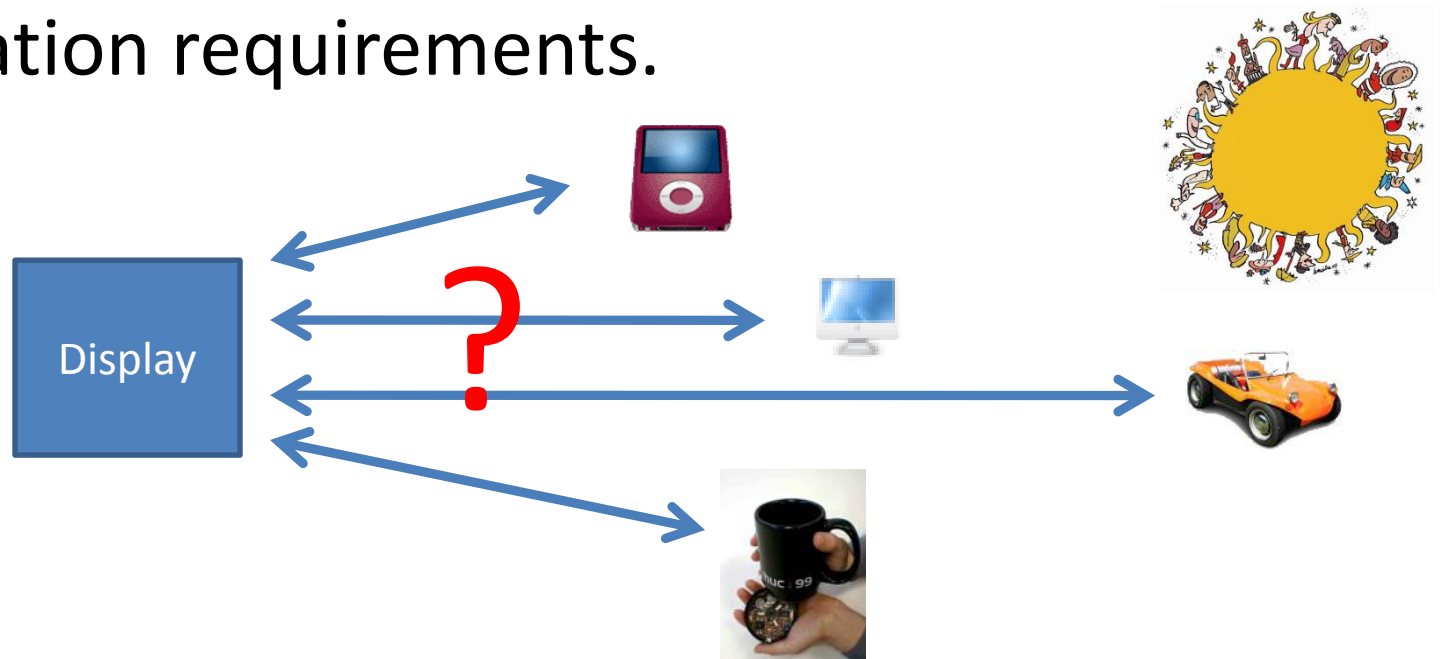

Can match with ?

Autonomy is the Key

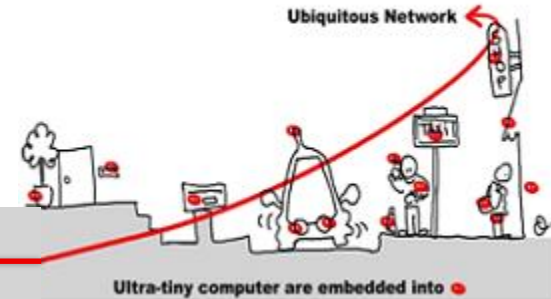

- Example :
 - Ambient Service Continuity
 - Context aware Computing
 - Autonomic Computing
- Which manage adaptation
- End / Expert user can't react instead of the system
- From software adaptation to automatic or **self-adaptation** ...
- Manual Adaptation
- Automatic Adaptation

David Garlan, Bradley Schmerl, and Shang-Wen Cheng, "Software Architecture-Based Self-Adaptation" in *Autonomic Computing and Networking*, M.K. Denko et al. (eds.), DOI 10.1007/978-0-387-89828-52, C Springer Science+Business Media, LLC 2009

Self-adaptive System Definition

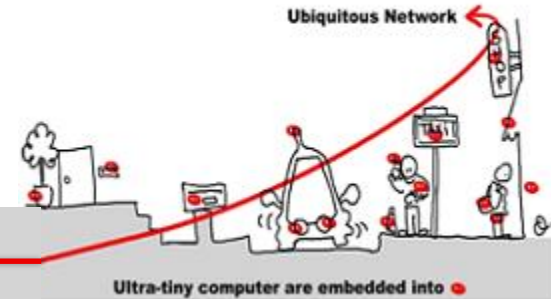

By **self adaptive** we mean systems and components that configure themselves and dynamically adapt to changing environments with minimal human participation.

Many systems have some degree of self-adaptiveness, but the abilities vary:

- static systems: parameter adaptation
- dynamic systems: compositional adaptation



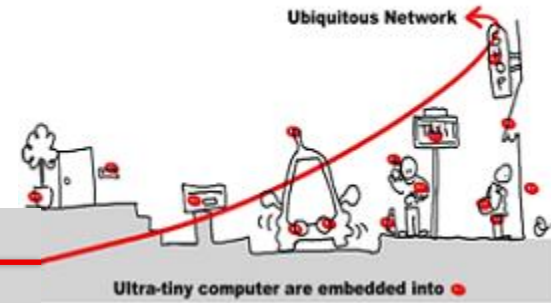

SOFTWARE SELF-ADAPTATION FOR AUTONOMOUS SYSTEMS

Different Points of view ...

CANAL, Carlos, MURILLO, Juan Manuel, POIZAT, Pascal, *et al.* Software Adaptation. *L'objet*, 2006, vol. 12, no 1, p. 9-31.

Reconfiguration (Design Time) towards Dynamic Adaptation (Runtime)

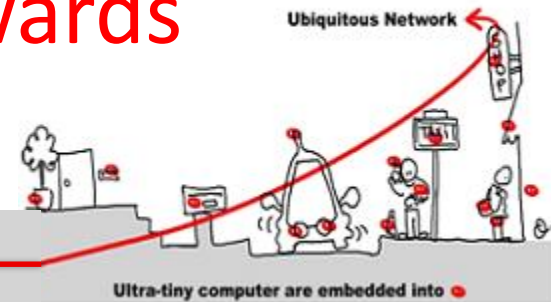

- Static Middleware
 - Customizable Middleware
 - Enables developers to compile (and link) customized versions of applications.
 - Configurable Middleware
 - Enables administrators to configure the middleware after compile time.
- Dynamic Middleware
 - Tunable Middleware
 - Enables administrators to fine-tune applications during run time.
 - Mutable Middleware
 - Enables administrators to dynamically adapt applications at run time.

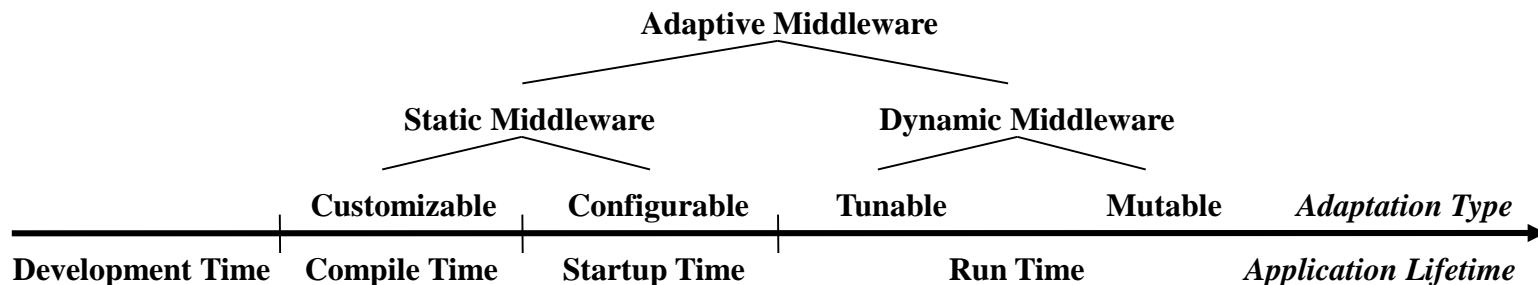

General Description

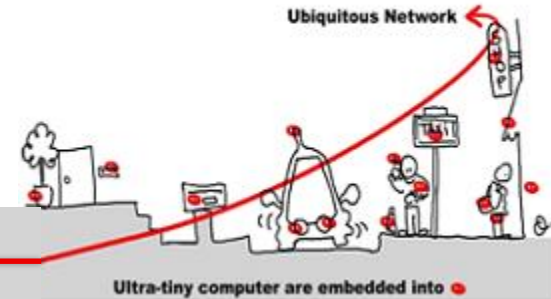

Abstract service to
maintain

Service
Description
Analysis (1)

Reasoning / plan
adaptation
computing (3)

Adaptation / plan
execution (2)

Service oriented Application

Service oriented Infrastructure

Services orientes Adaptation : Levels of Heterogeneity (1)

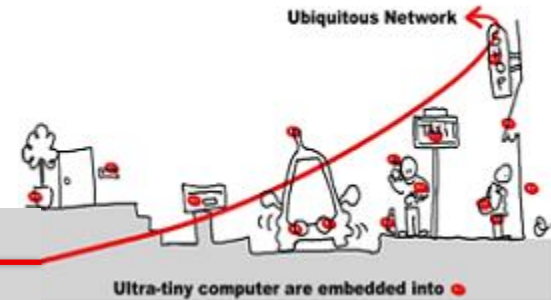

- We can distinguish between several levels of Heterogeneity, and accordingly of Service interface description :
 - Signature level
 - Behavioral level
 - Semantic level
 - Service level or QoS

Adaptivity classes (2)

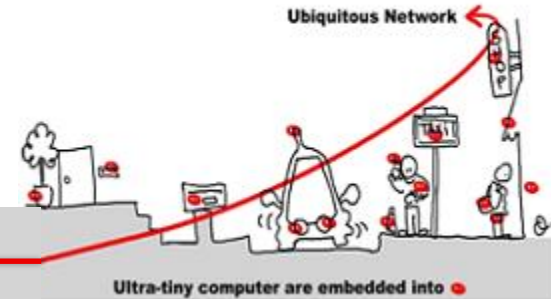

- **Parameter adaptation**: changing values without changing components or algorithms.
- **Compositional adaptation**:
 - **Structural** – changing parts and part structure
 - **Behavioral** – changing behavior/types and algorithms

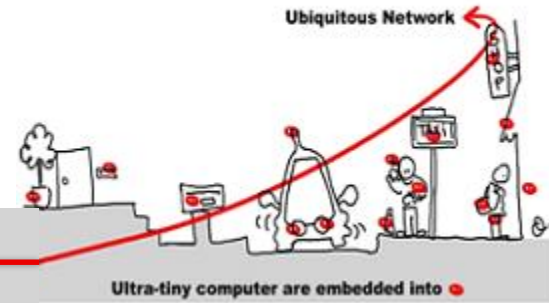

Some Key Paradigms and Taxonomies for Adaptation (3)

Computational Reflection
Component-Based Design
Aspect-Oriented Programming
Software Design Patterns

Some middleware Paradigms for Adaptation

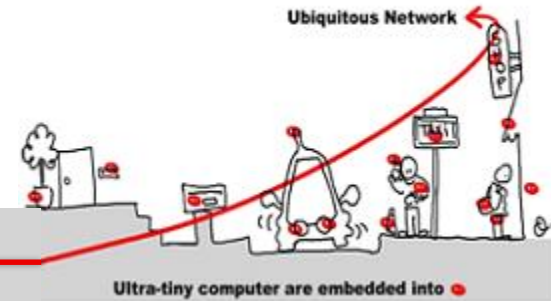

- Reconfiguration (Design Time) to Dynamic Adaptation (Runtime)
- Computational Reflection
- Policy-based adaptation
- Aspect-Oriented Programming

Computational Reflection

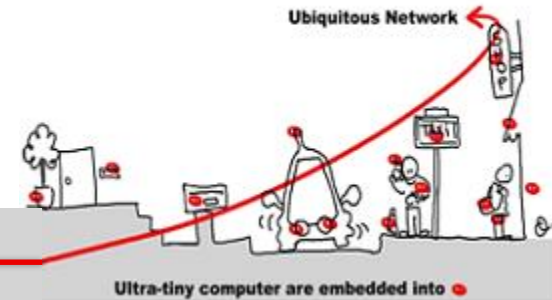

- The ability of a program to reason about, and possibly alter, its own behavior.
- Enables a system to “open up” its implementation details for such analysis without revealing the unnecessary parts or compromising portability.
- Terminology

- * Base-level
- * Meta-level
- * MOP
- * Casually connected
- * Per-ORB, per-class, per-object, and per-interface reflection

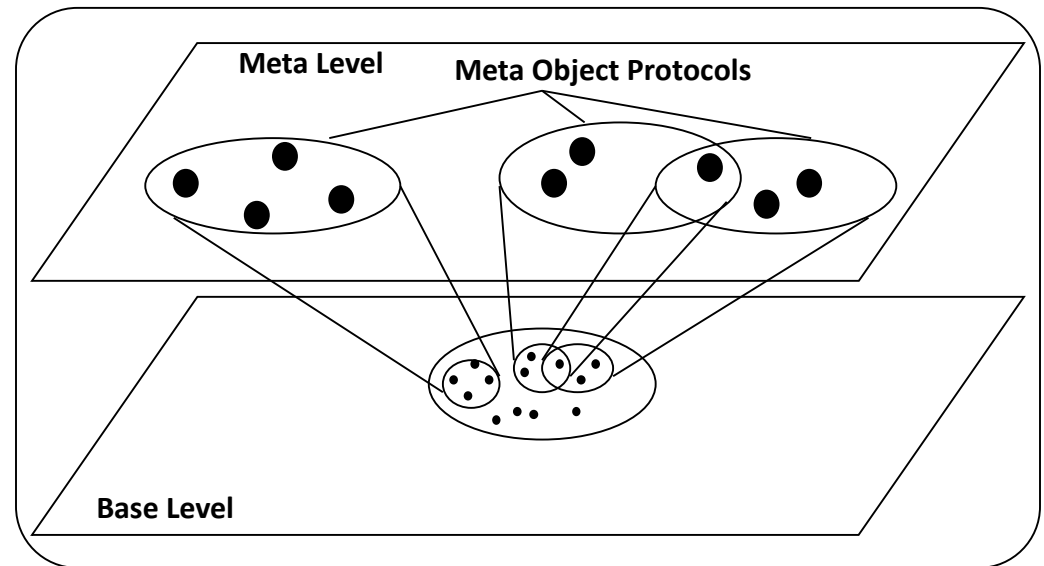

Relationship between meta-level and base-level objects.

Policy-based adaptation

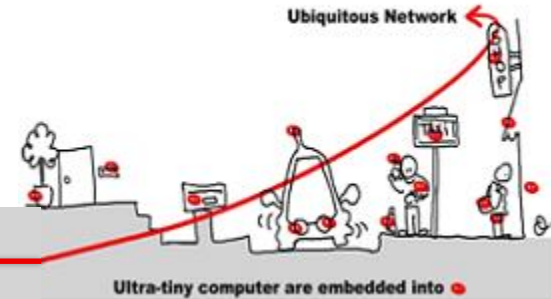

Policy Rules :

Particular conditions -> matching rules



Middleware :

selected script -> behavior modification

- Policy rules are often context based
- Example : ECA (Event-Condition-Action) rules
 - The event part specifies the context change that triggers the invocation of the rules
 - The condition part tests if this context change is satisfied
 - Which causes the description of the adaptation (action) to be carried out

Aspect-Oriented Programming

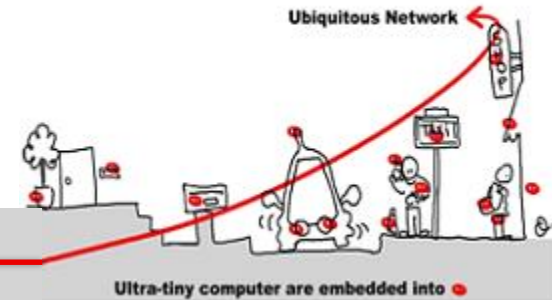

- Complex programs are composed of different intervened cross-cutting concerns.
- Cross-cutting concerns:
 - Properties or areas of interest such as QoS, energy consumption, fault tolerance, and security.
- Terminology

- * Aspect
- * Basic Functionality
- * Aspect Language
- * Aspect Weaver
 - * Static
 - * Dynamic
- * Woven Code

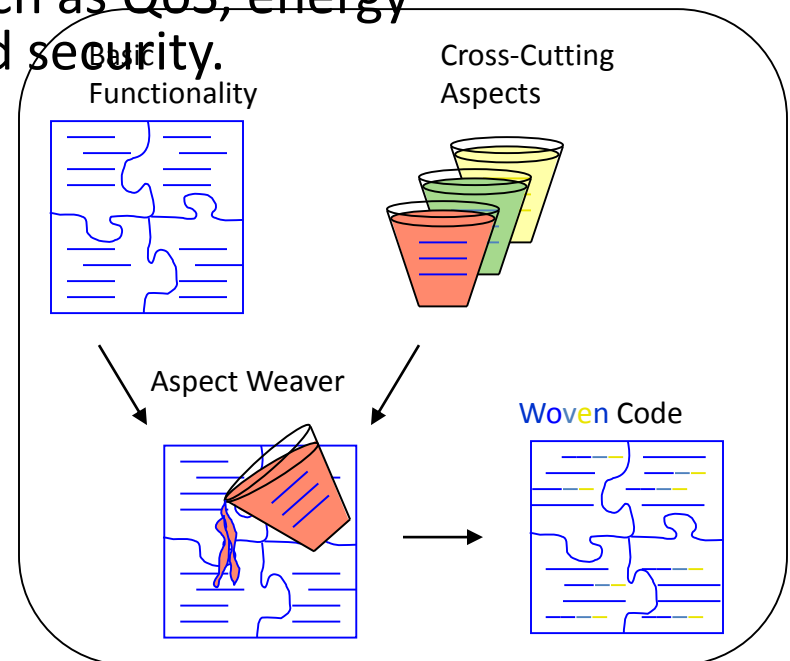

AOP in action.

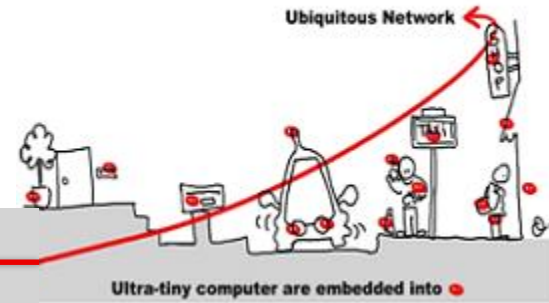

NEXT LECTURE :

Aspects of Assemblies Approach

For structural self-adaptation

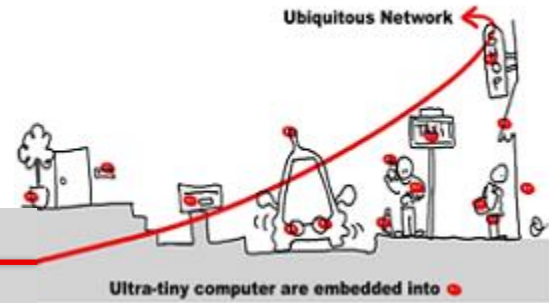

Aspect of Assembly Concept for self-adaptation

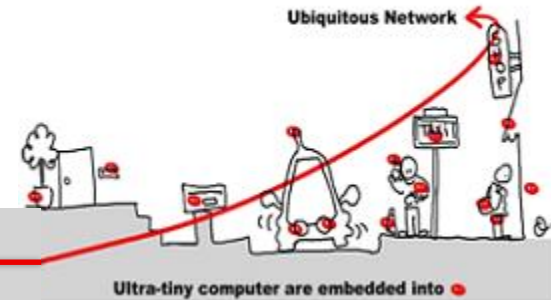

- From AOP Principles
- Aspect of Assembly Principles
- Complete AA Weaving Cycle
- Different kinds of conflict resolution

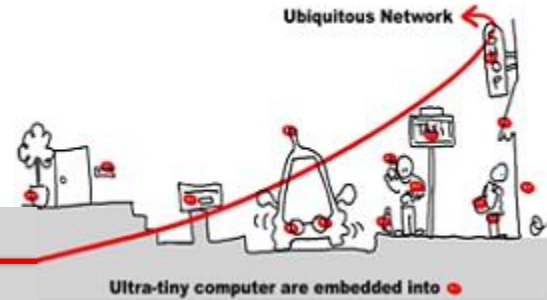

Reminder : AOP Principles

```
public class HelloWorld {
    public static void main (String[] args) {
        new HelloWorld().sayHello();
    }
    public void sayHello () {
        system.out.println("Hello World!");
    }
}
```

Weaver

Pointcuts Matching
Advices Application

1
2

```
public class HelloWorld {
    public static void main (String[] args) {
        System.out.println("Hello One...");
        new HelloWorld().sayHello();
        System.out.println("Hello Two...");
    }
    public void sayHello () {
        system.out.println("Hello World!");
    }
}
```

```
pointcut Two():
    execution(*HelloWorld.sayHello(..));
```

```
before():Two() {
    System.out.println( "Hello One ...");
}
```

Aspect of Assembly Principles

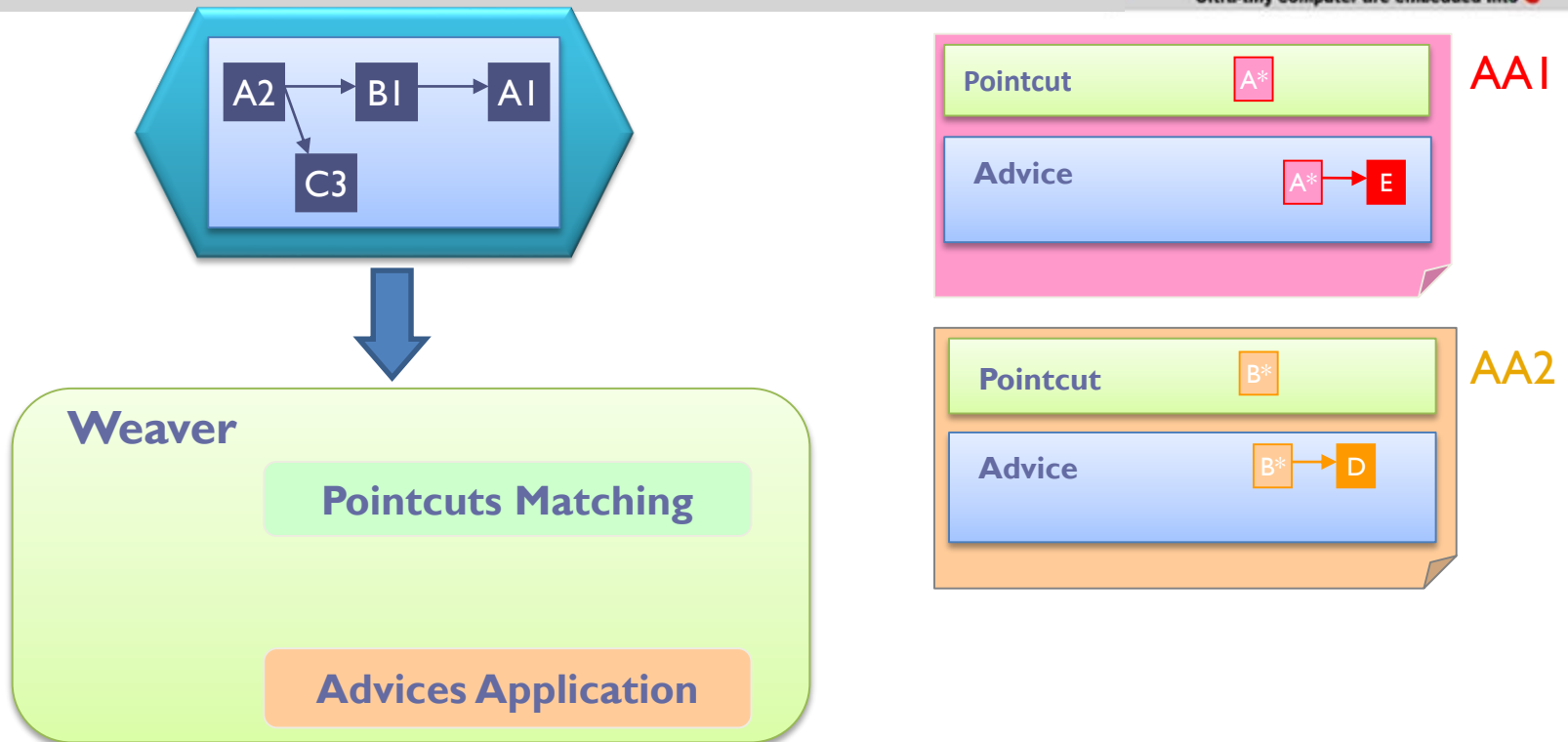
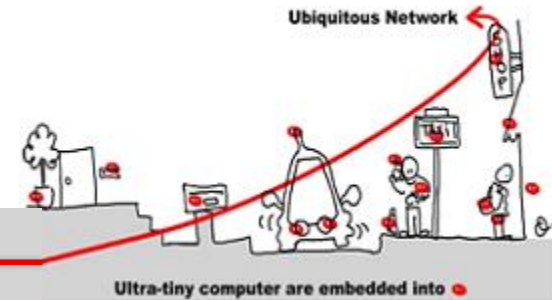

AOP inspired for Component based approach
(like LCA)

Aspect of Assembly Principles

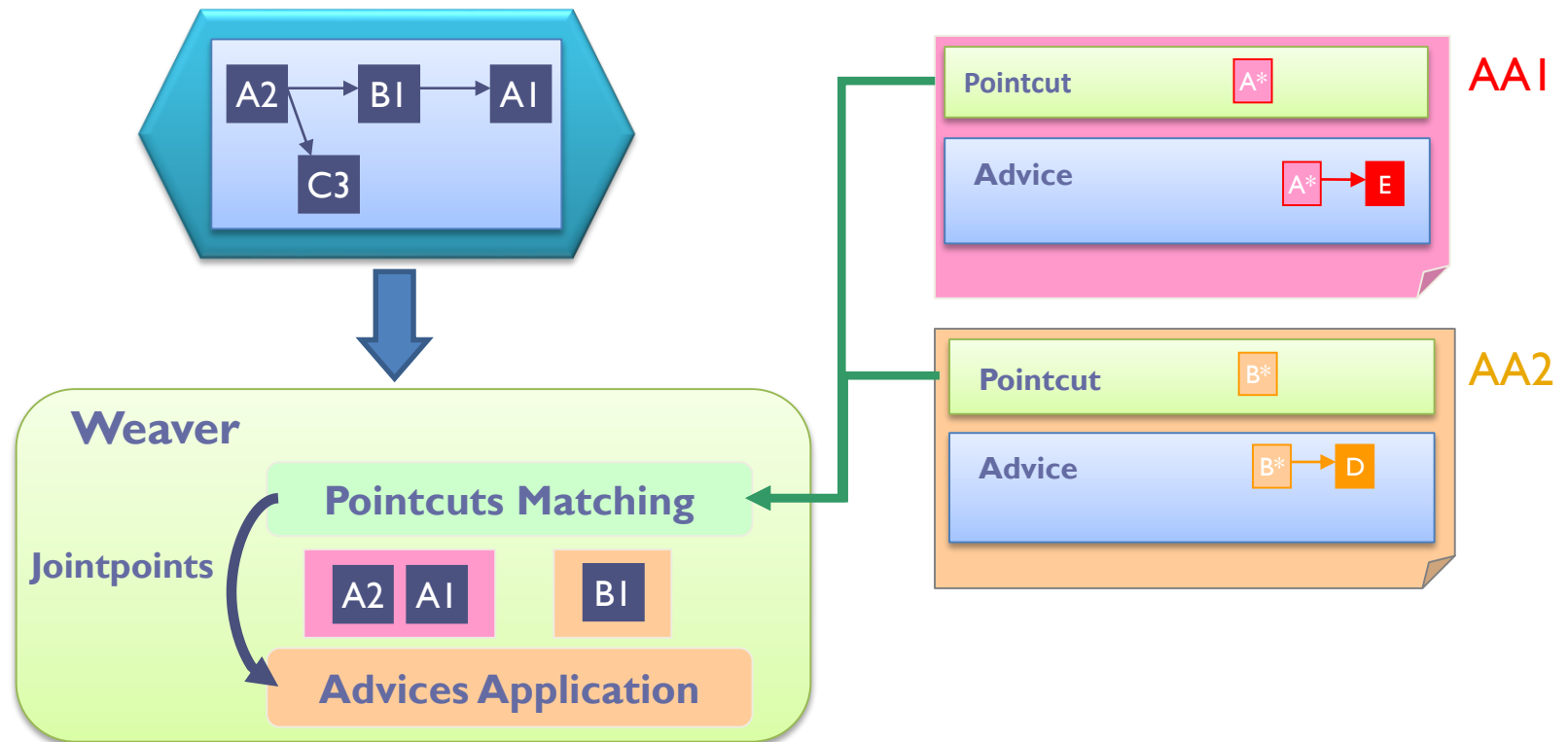
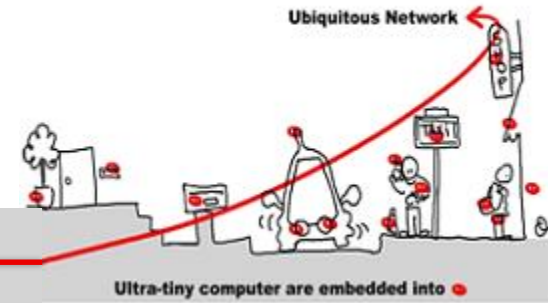

Aspect of Assembly Principles

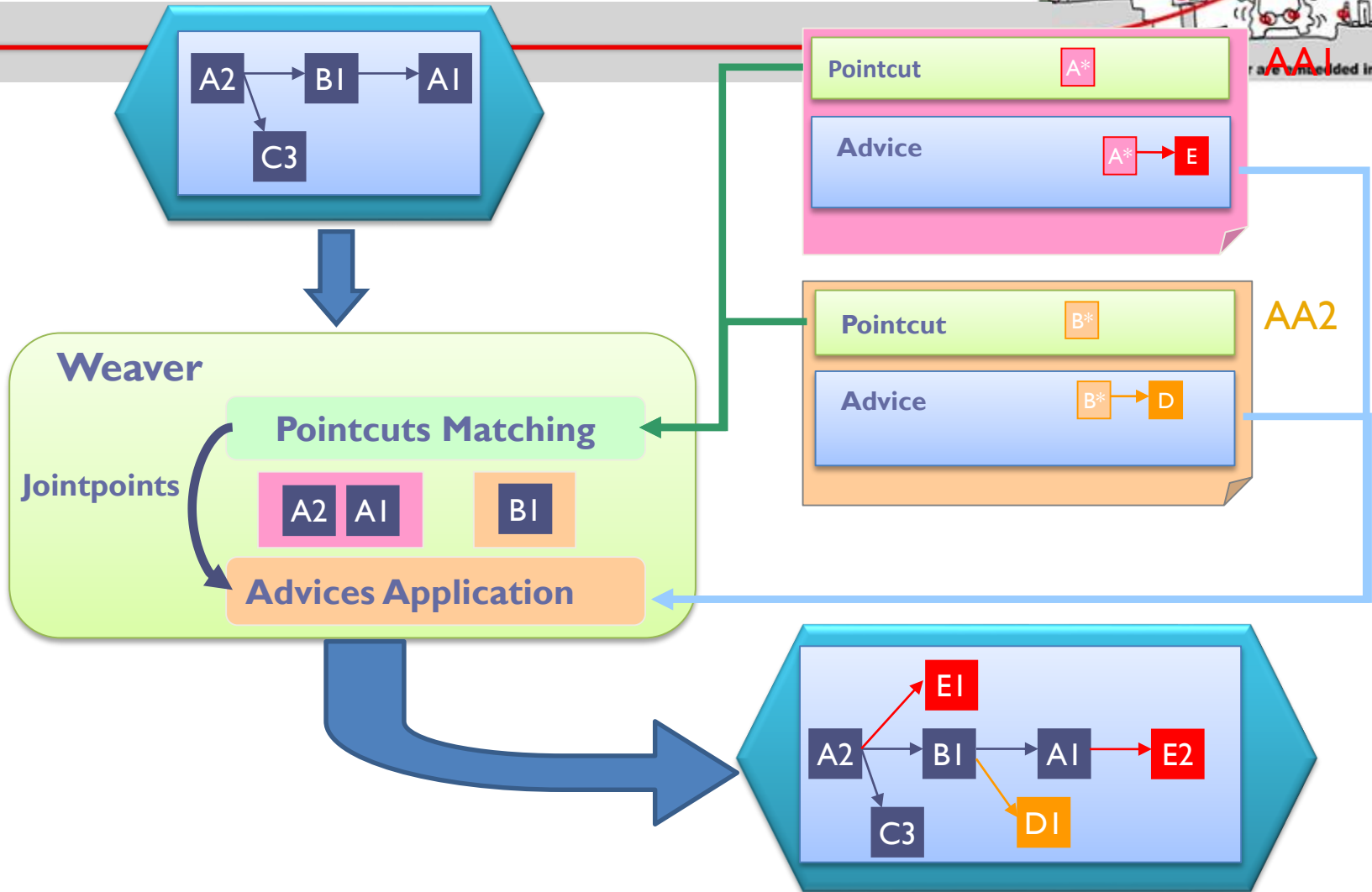
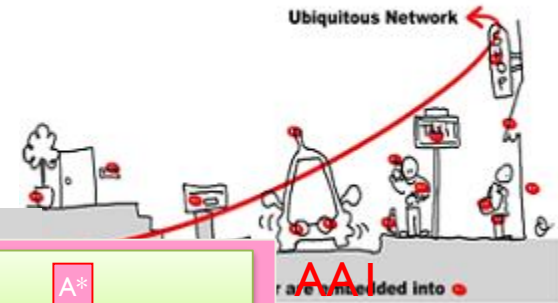

Complete AA Weaving Cycle

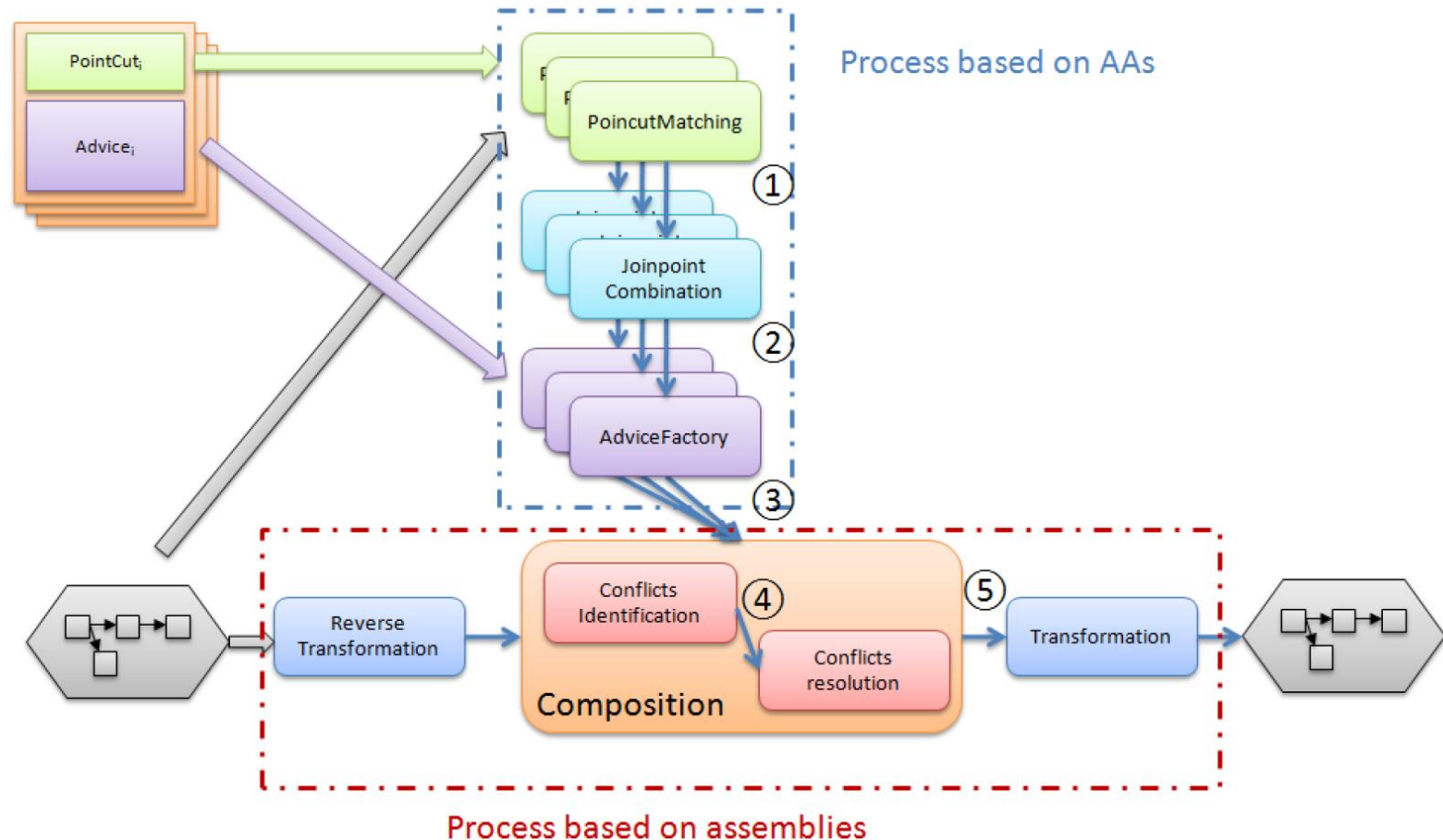
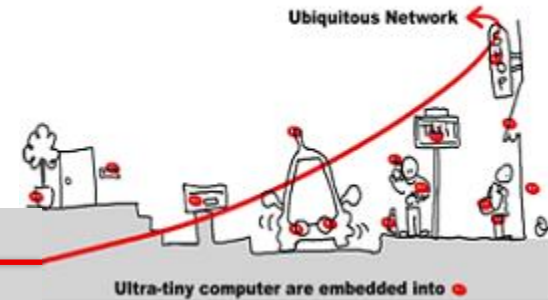

Pointcut Matching (1)

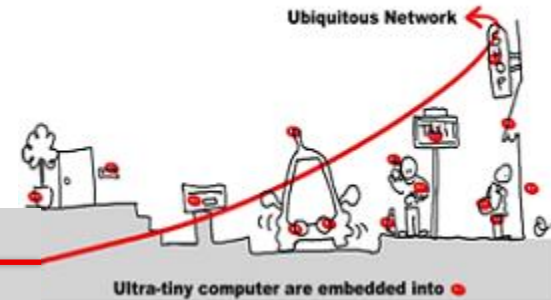

- Pointcut Matching aims to determine in the base assembly all areas where changes described in an AA can be applied.
- Indeed, it is a filter that takes as input all the ports present in the application.
- It is parametrized by the rules defined in the pointcut section of the AA.
- It produces some lists of joinpoints that satisfy each rule and more precisely, a list for each rule.

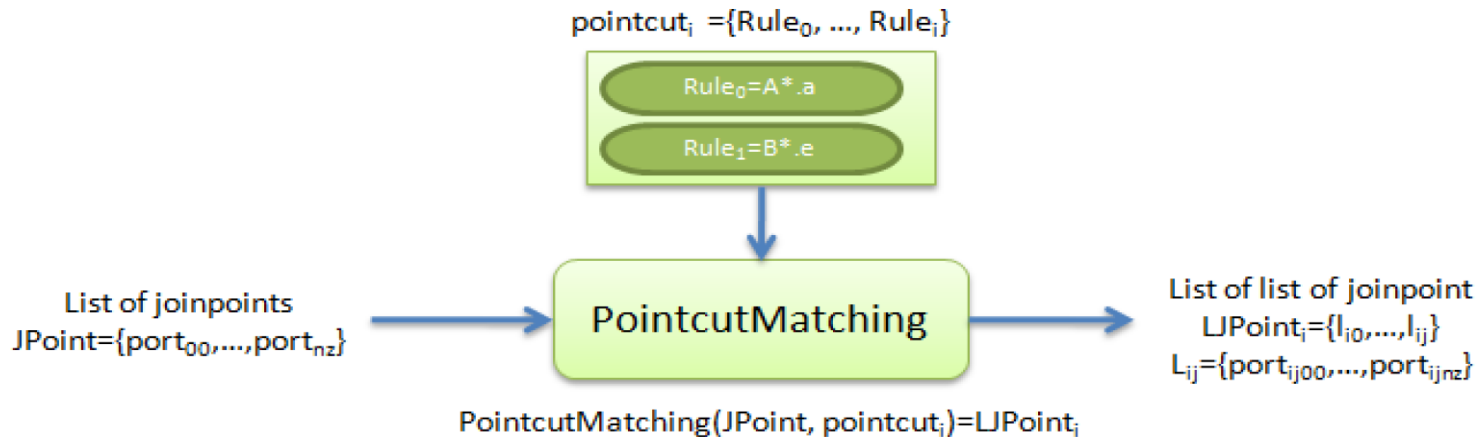

Pointcut Matching Example

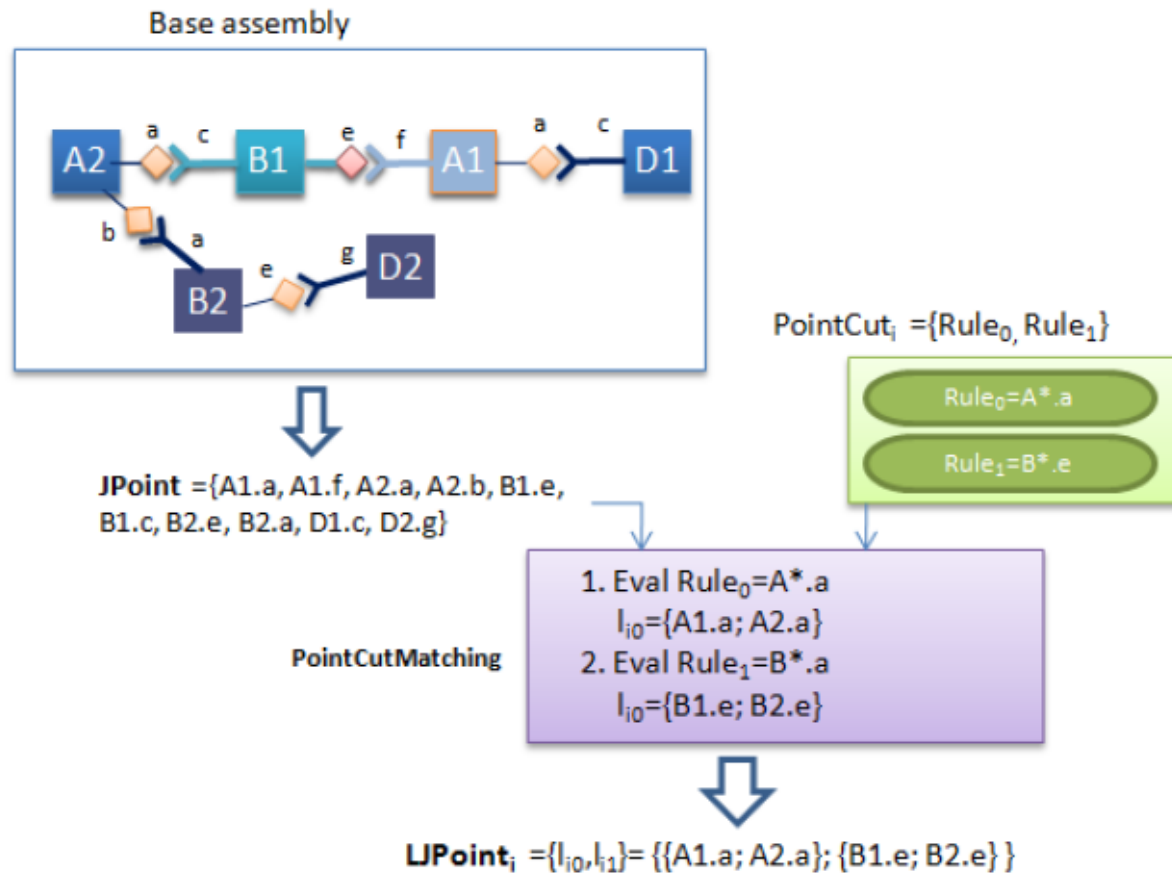
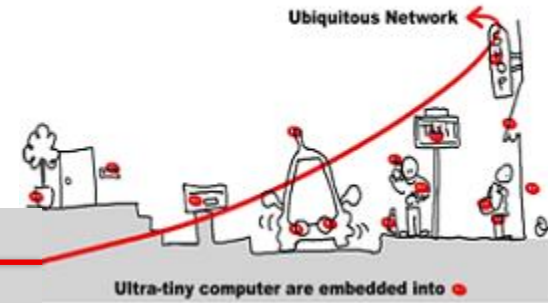

Pointcut Matching Algorithm

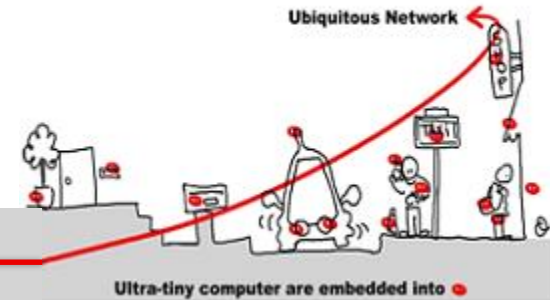

Algorithm 1 *PointcutMatching*(*JPoint*, *PointCut_i*)

l_{ij} : a list of ports (joinpoint) where $l_{ij} = port_{ij00}, \dots, port_{ijnz}$ and j is the number of list which is equal to the number of rules in *PointCut_i*

$LJPoint_i$: a set of joinpoint lists where $LJPoint_i = \{l_{i0}, \dots, l_{ij}\}$

JPoint : the set of ports from the base assembly $port_{00}, \dots, port_{nz}$ y.

create $LJPoint_i$

for $s = 0$ to j **do**

 Add a new list l_{is} to $LJPoint_i$

for $t = 0$ to $\text{card}(JPoint)$ **do**

if $JPoint[t]$ satisfy the rule $Rule_{is}$ **then**

 Add $JPoint[t]$ to the list l_{is}

end if

end for

end for

Jointpoint Combination (2)

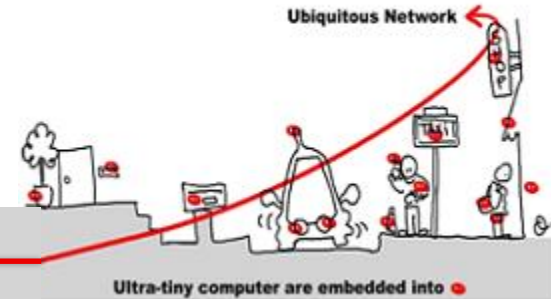

- Joinpoint combination and filters
- Join Point Combination aims to combine joinpoints that satisfy the pointcut matching according to various policies in order to define how and where will be duplicated the AA.
- Joinpoints lists created identify all ports that check pointcut rules, in fact a list for each rule. To be applied, advices require at least an element of each list : a combination.
- Thus, an advice can be applied as many times as there are combinations of joinpoints between these lists.

List of list of joinpoint
 $LJPoint_i = \{l_{i0}, \dots, l_{ij}\}$
 $L_{ij} = \{port_{ij00}, \dots, port_{ijnz}\}$



$JPCombination(LJPoint_i) = JPointComb_i$

Jointpoint Combination Example

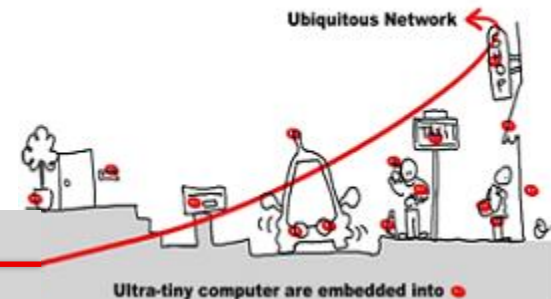

$LJPoint_i = \{l_{i0}, l_{i1}\} = \{\{A1.a; A2.b; A2.c\}; \{B1.e; B2.f\}; \{c1.g\}\}$

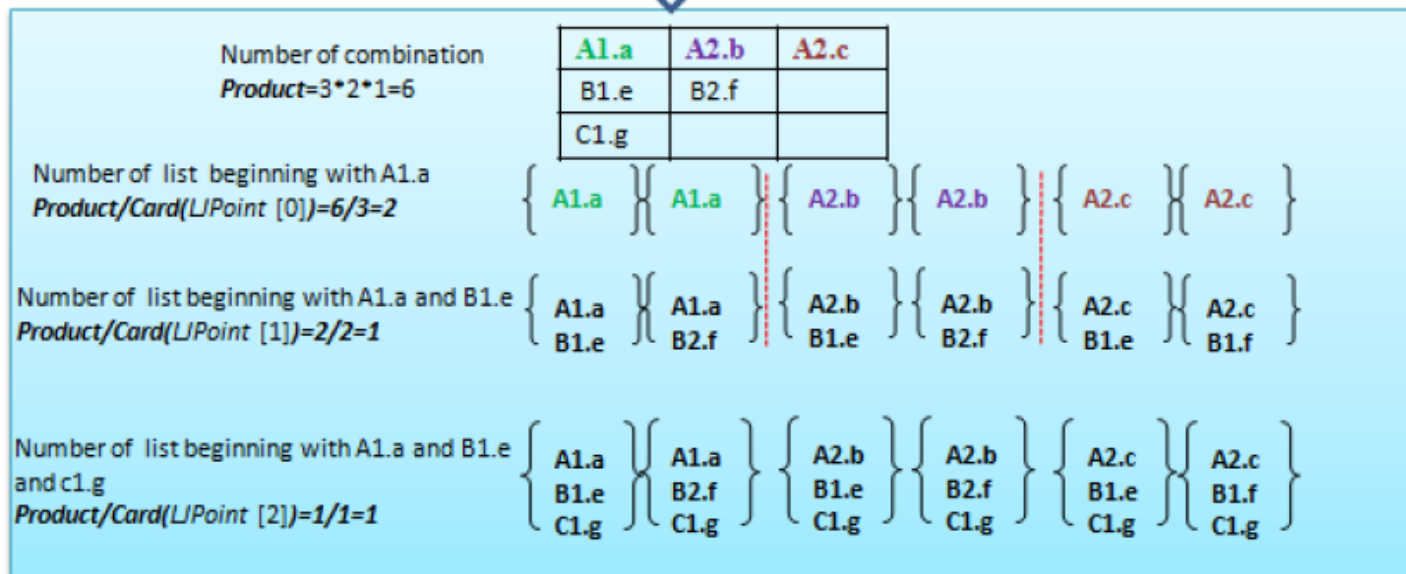

$JPointComb_i = \{Comb_{i0}, Comb_{i1}, Comb_{i2}, Comb_{i3}, Comb_{i4}, Comb_{i5}\} = \{(A1.a, B1.e, C1.g); (A1.a, B2.f, C1.g); (A2.b, B1.e, C1.g); (A2.b, B2.f, C1.g); (A2.c, B1.e, C1.g); (A2.c, B1.f, C1.g)\}$

Jointpoint Combination Algorithm

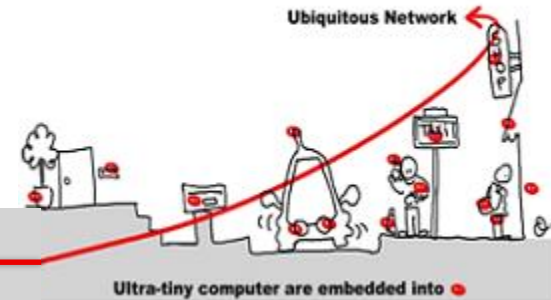

Algorithm 2 JPCombination($LJPoint$)

ACombination: list of joinpoint
Product: Integer : number of possible combination
mult : Integer : number of combination using the joinpoint
lcomb: list of combination

```
mult=1;
create JPointComb
for  $i = 0$  to  $card(LJPoint)$  do
  Create lcomb
  ACombination.Clean
   $product = product / (card(LJPoint[i]) - 1)$ 
  for  $j = 1$  to  $card(LJPoint[i])$  do
    for  $k = 0$  to  $product$  do
      ACombination.Add( $LJPoint[i][j]$ )
    end for
  end for
  for  $j = 1$  to  $mult$  do
    lcomb.Add(ACombination)
  end for
  JPointComb[i]= lcomb
   $mult = mult \times (card(LJPoint[i]) - 1)$ 
end for
return JPointComb
```

Filter Algorithm

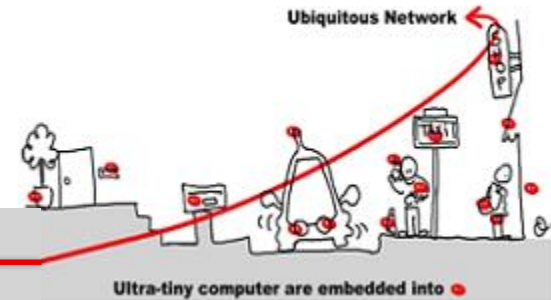

- To Pointcut Matching and combination mechanisms may be associated some filters.
- The filter associated to the pointcut matching can withdraw some identified joinpoints.

Algorithm 3 Filter

```
j : number of combination  
  
for s = 0 to j do  
  for t = 0 to card(LJPointi[j]) do  
    if filtre(lis[t]) then  
      lis.remove(t)  
    end if  
  end for  
end for
```

Advice Factory (3)

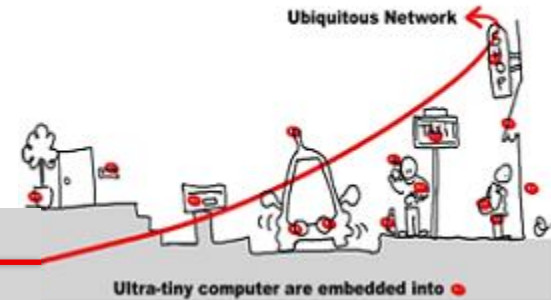

- AdviceFactory aims to build, from the list of joinpoint combination, instances of advice.
- Thus it create as many instances of advice as possible according to the list of combinations.
- It consist in replacing variables from advice rules with the joinpoint from each combinations.

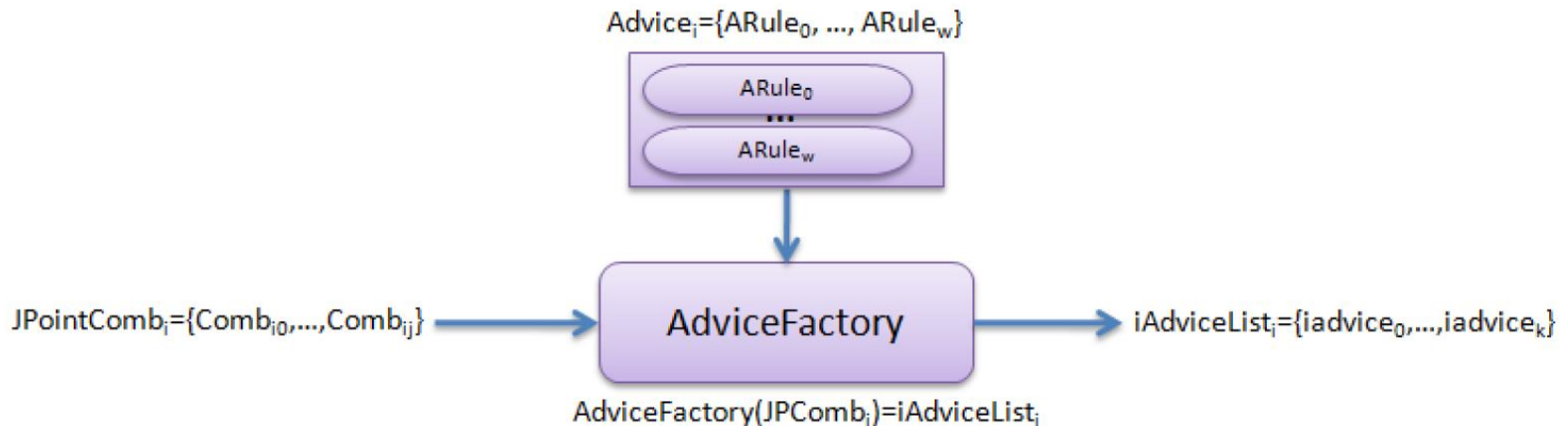

Advice Factory Algorithm

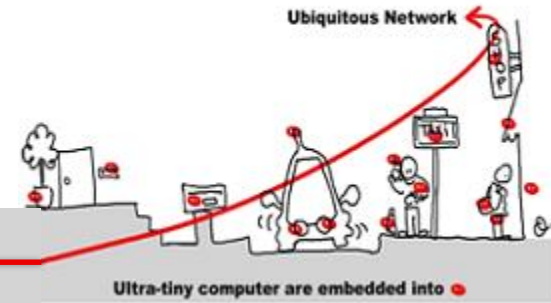

Algorithm 4 AdviceFactory($JPointComb_i$)

k : number of combination

w : number of advice rules

for $s = 0$ to k **do**

for $t = 0$ to w **do**

 Replace variable from $ARule[t]$ using $JPointComb[s]$

end for

end for

Conflict Identification (4)

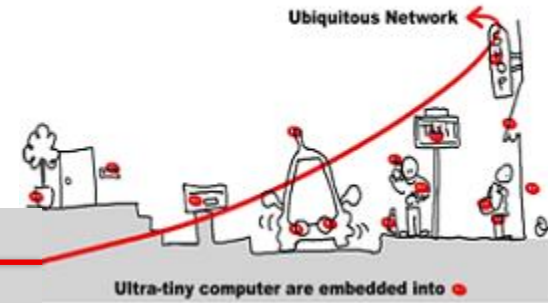

- Superimposing component assemblies is a mechanism that builds a unique assembly from several intermediates component assemblies (and thus instances of advices).

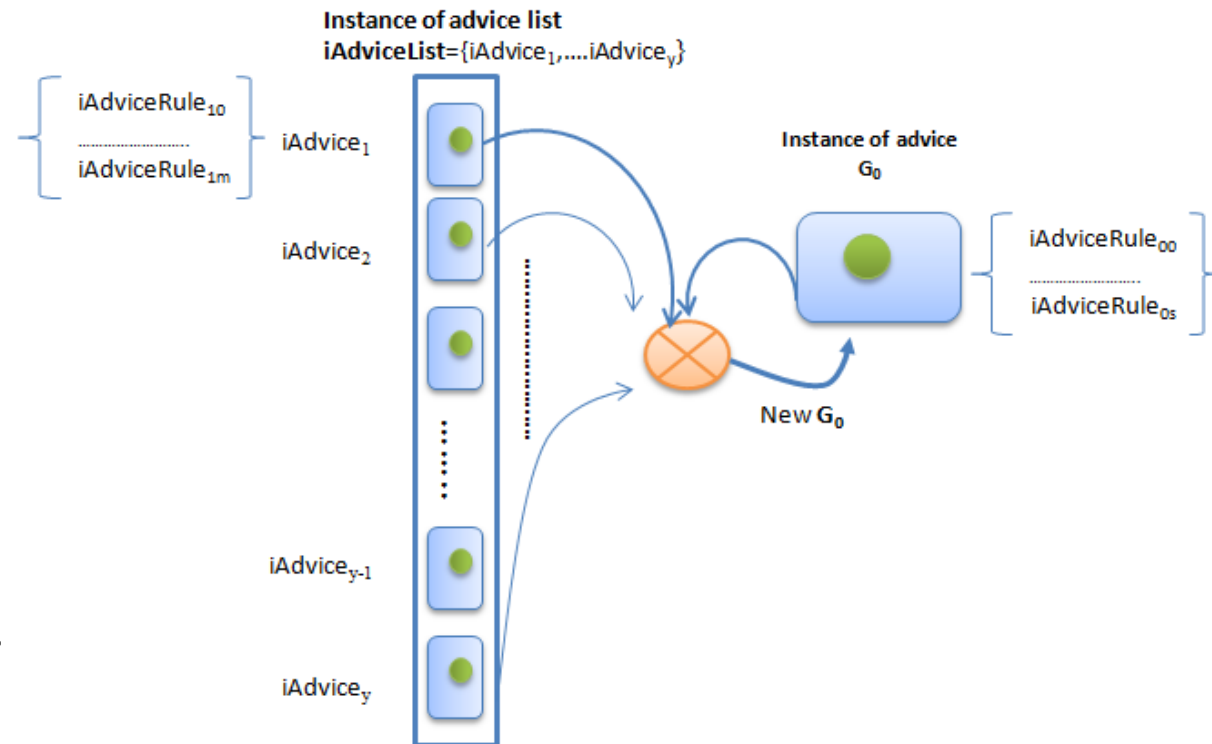

Superimposition Algorithm

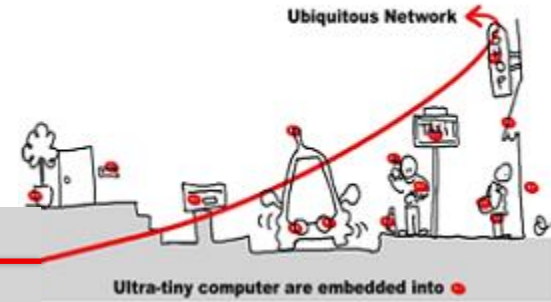

Algorithm 5 Superimpose(*iAdviceList*)

y : number of instance of advice

```
for d = 0 to y do
  for t = 0 to card(iAdviced) do
    if iAdviced[t] NotInG0 then
      Add iAdviced[t] to G0
    end if
  end for
end for
```

Conflict Resolution (5)

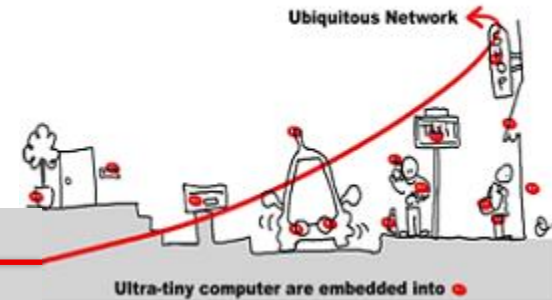

- Conflict resolution aims to solve conflicts occurring when several instances of advices are woven on the same joinpoint (shared joinpoints)

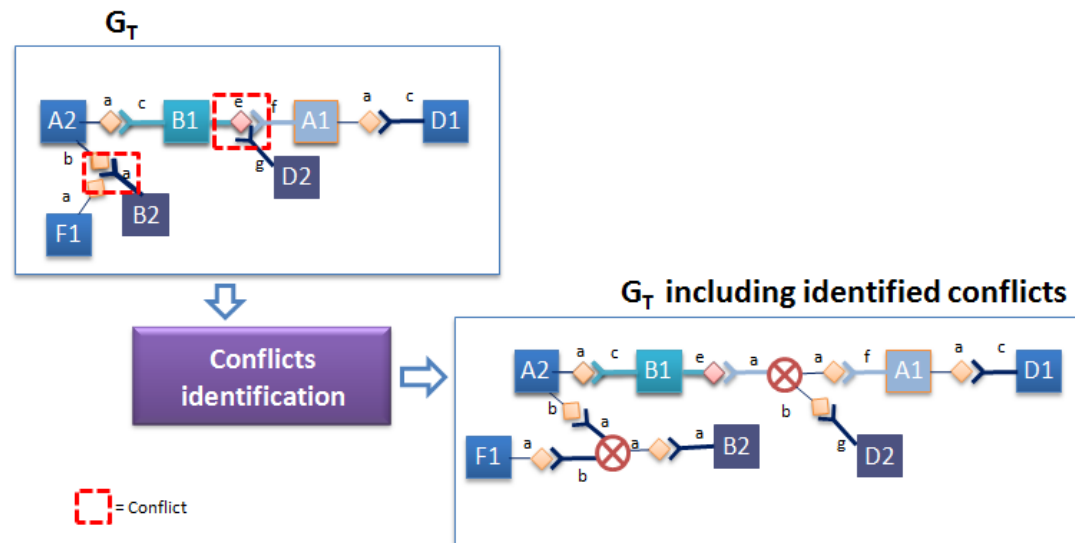

Conflict Resolution Algorithm

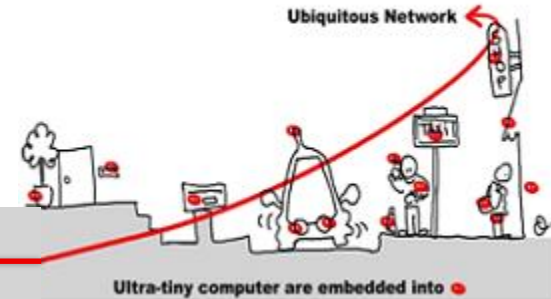

- Depends on the merge strategy
- Then depends on the Merge function

Algorithm 6 ConflictResolution(iAdvice)

```
for  $s = 0$  to  $\text{card}(List \otimes)$  do  
    Merge( $List \otimes [s]$ )  
end for
```

Different kinds of Conflicts Resolution

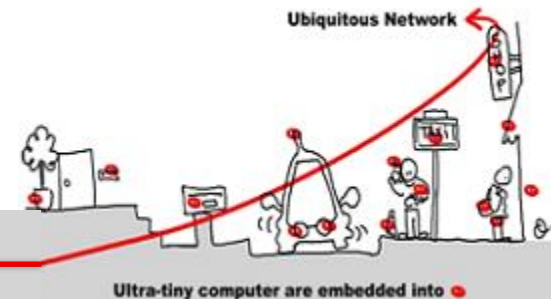

- External resolution for conflicts
- Internal resolution for conflicts (merge)
 - Example of language to describe advice : ISL4WComp
 - ISL4WComp operators merging matrix
 - Merging logic and its properties

External Composition

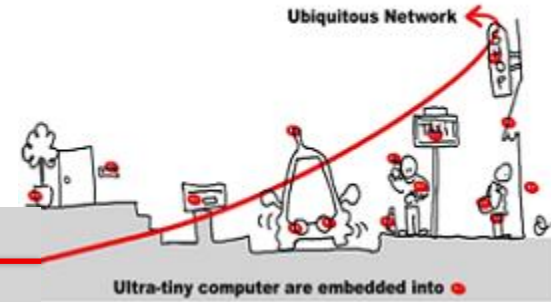

- I-Advices are « blackbox »
- I-Advices are scheduled
- Before, After, Around ...

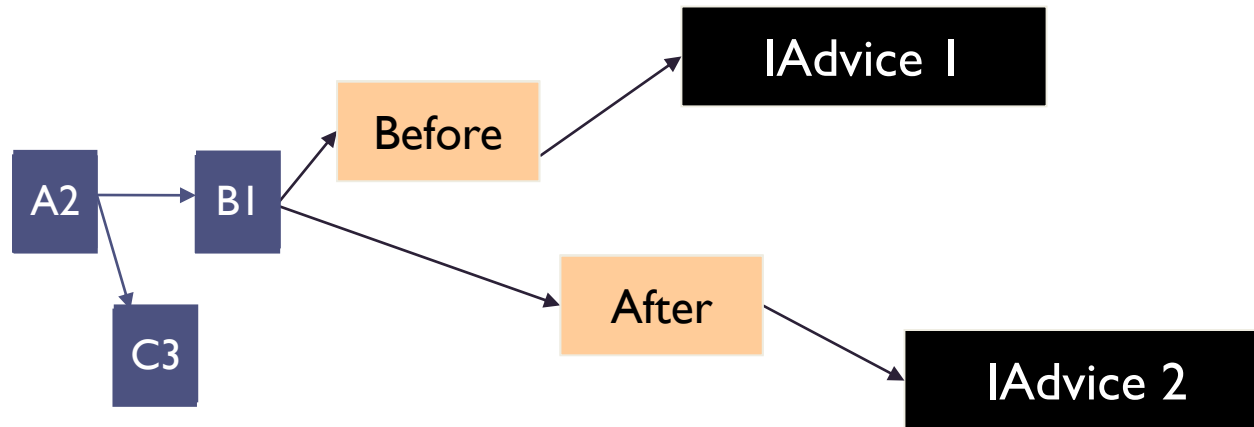

Internal Composition with Merge

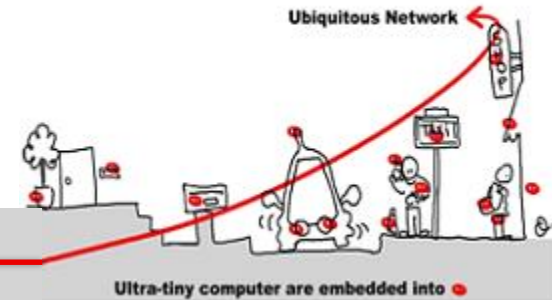

- I-Advice are « whitebox »
- Conflicted I-Advices can be merged according to a specific logic and its properties (ex. ISL, ISL4WComp, BSL ...)

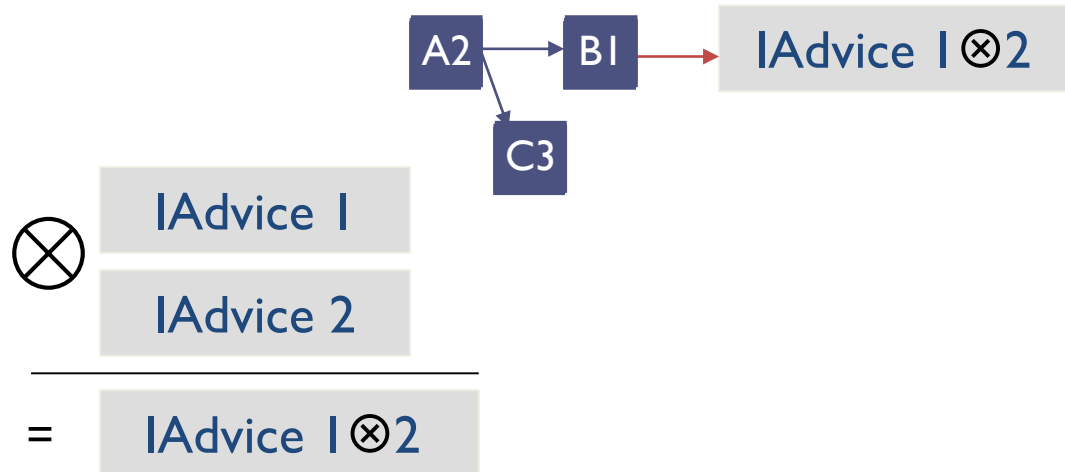

Example of language to describe advice : ISL4WComp

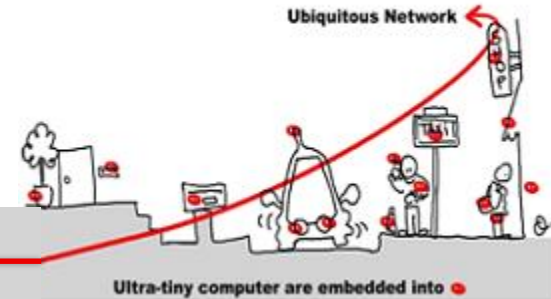

- Operators are :
 - ; (seq)
 - || (par)
 - If / else
 - Nop
 - Call
 - delegate

	Keywords / Operators	Description
port types	<i>comp.port</i>	'.' is to separate the name of an instance of component from the name of a port. It describes a provided port.
	<i>comp.^ port</i>	'^' at the beginning of a port name describes a required port.
Rules for structural adaptations	<i>comp : type</i>	To create a black-box component
	<i>comp : type (prop = val, ...)</i>	To create a black-box component and to initialize properties
	required_port → (required_port)	To create a link between two ports. The keyword → separates the right part of the rule from its left part
	provided_port → (required_port)	To rewrite an existing link by changing the destination port
Operators (symmetry property, conflicts resolution)	... ; ...	Describes the sequence
	To describe that there is no order (parallelism)
	if (condition) {...} else {...}	condition is evaluated by a black-box component
	nop	Nothing to do
	call	Allow to reuse the left part of a rule in a rewriting rule
	delegate	Allow to specify that an interaction is unique in case of conflict

ISL4WComp Operators Merging Matrix

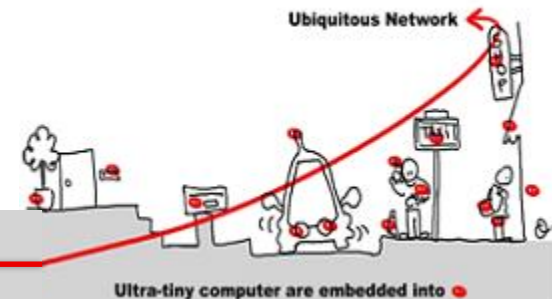

- Merging logic is based on rules to merge semantic trees of the advices
- Each rule gives the result of merging of one operator with another

	seq	delegate	composition	if	msg	call	nop
seq							
delegate		$\frac{\text{if (C) A else B} + \text{delegate D}}{\text{if (C) A+(delegate D) else B+(delegate D)}}$			1)	$\frac{\text{if (C) A else B} + \text{if (C) D else E}}{\text{if (C) A+D else B+E}}$	
composition					2)	$\frac{\text{if (C) A else B} + \text{if (C') D else E}}{\text{if (C\&C') A+D else if (C\&!C') A+E else if (!C\&C') B+D else if (!C\&!C') B+E}}$	
if							
msg							
call							
nop							

msg+call
msg

Merging Logic and its Properties

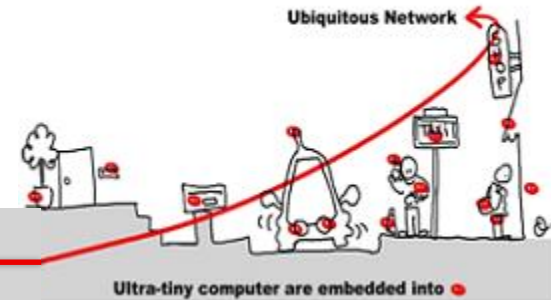

- Example of proved properties for a composition / merging logic :

Commutativity : $AA0 \otimes AA1 = AA0 \otimes AA1$

Associativity : $(AA0 \otimes AA1) \otimes AA2 = AA0 \otimes (AA1 \otimes AA2)$

Idempotence : $AA0 \otimes AA0 = AA0$

- Weaving mechanism becomes « Symmetric »
- It can apply a set of AA without caring of their order.

Details on AA temporal Validation (response time)

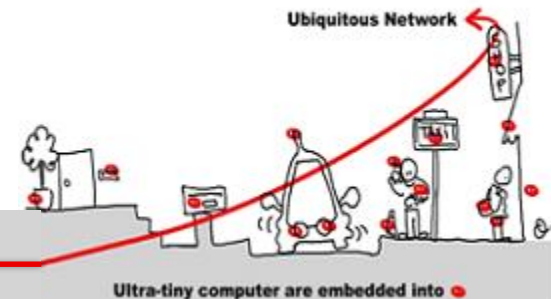

- To response in a timely fashion we need to guarantee a minimum response time
- To study the response time of the overall adaptation process based on AA, we need to study :
 - Each algorithm and its complexity
 - Temporal model of the response time and the identification of its parameters

Complete AA Weaving Cycle

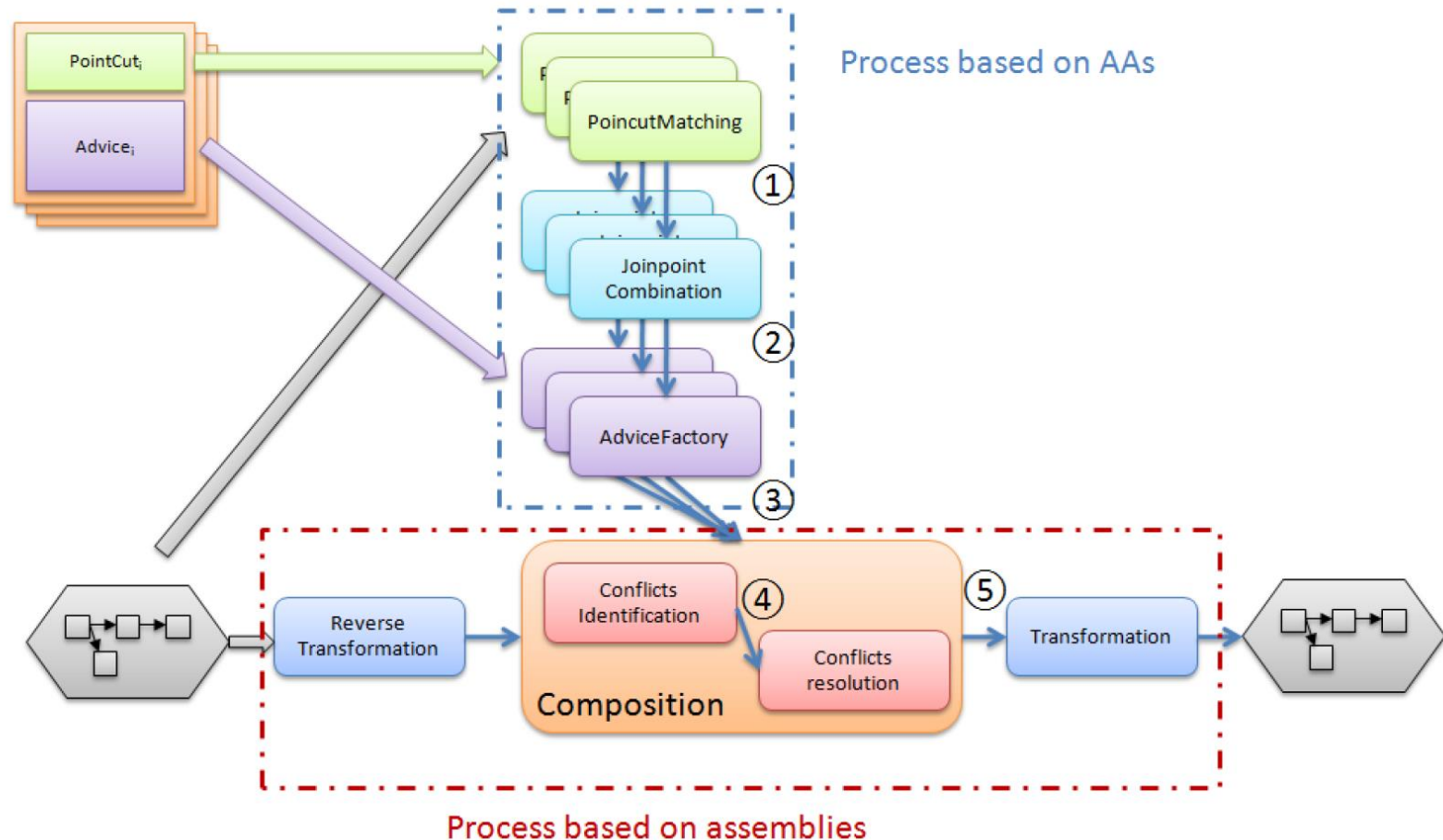
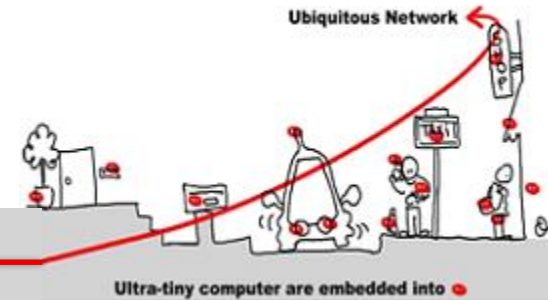

Pointcut Matching (1)

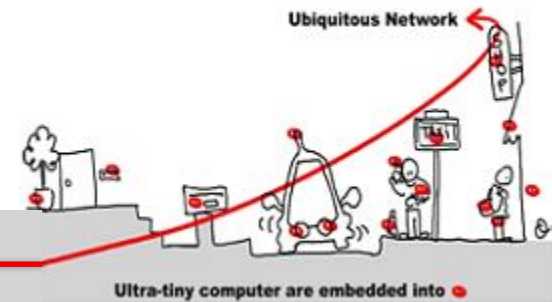

A : duration of the PointcutMatching process

$a1$; $a2$: model parameters

c : number of ports into the base assembly

i : number of AA

j : number of rules in the pointcut section of an AA

$$A = a1 \times \sum_{k=1}^i (j.c) + a2$$

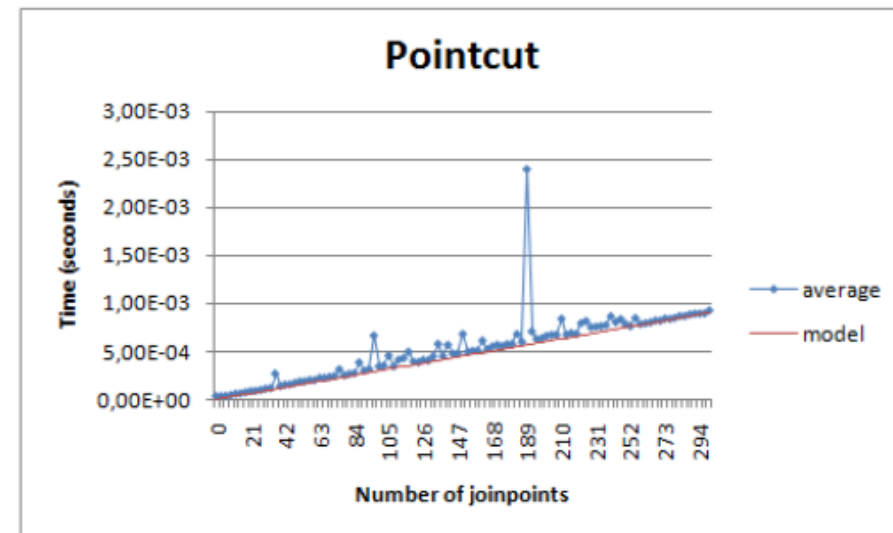

Joinpoint Combination (2)

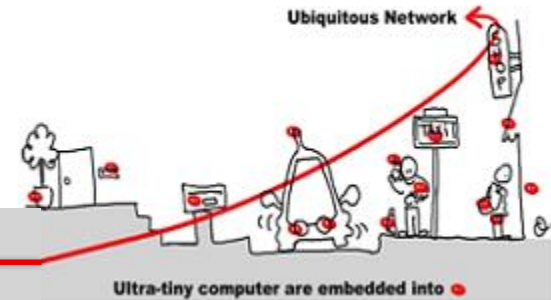

C : Duration of the joinpoint combination process

$a1; a2$: model parameters

$JPoint$: the set of joinpoints

i : number of AA

j : number of rules in the pointcut section of an AA

$$C = a1 \times \sum_{k=1}^i (card(JPoint)^j) + a2$$

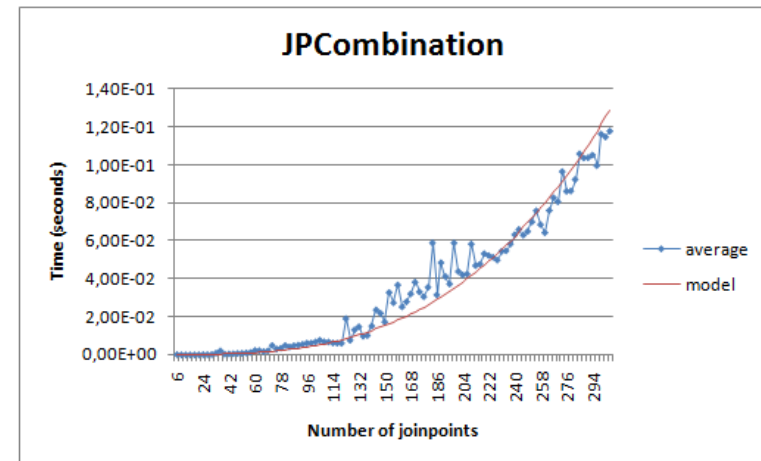

Advice Factory (3)

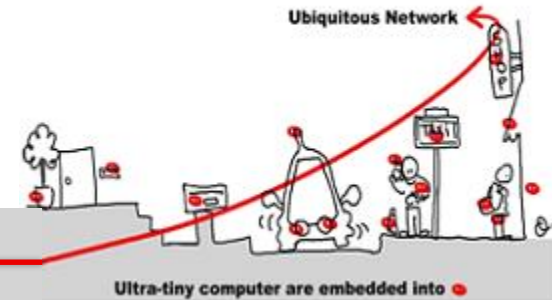

A : duration of instance of advice generation

k : number of combination

w : number of advice rule

$a1; a2$: model parameters

$$A = a1 \times \sum_{k=1}^i (kw) + a2$$

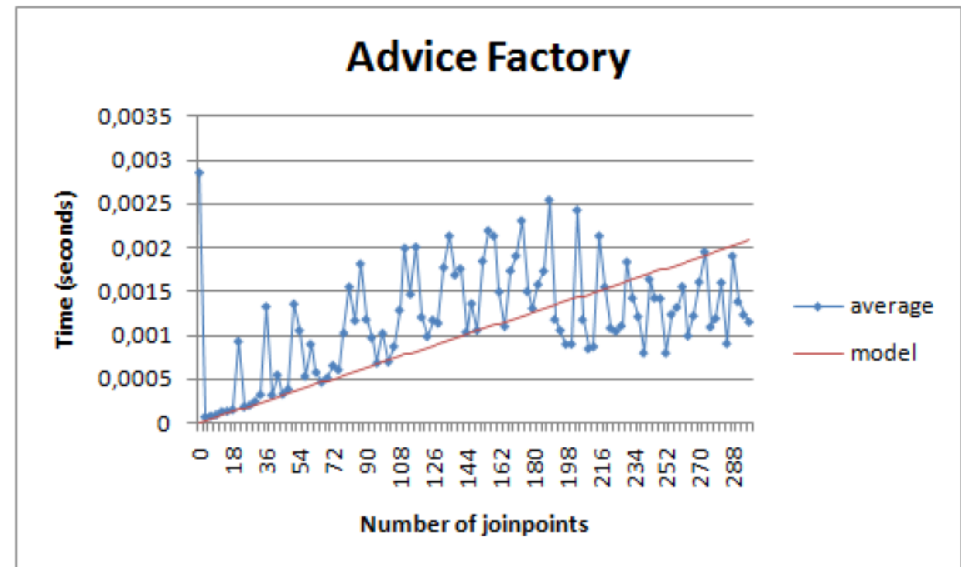

Conflict Identification (4)

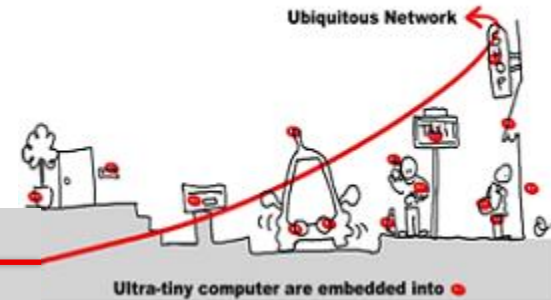

S : duration of instance of advice superposition

y : number of instance of advice

w : number of advice rule

g_0 : number of rules in the initial instance of advice

$a_1; a_2$: model parameters

$$S = a_1 \times \sum_{i=1}^y (w_i \cdot g_0) + a_2$$

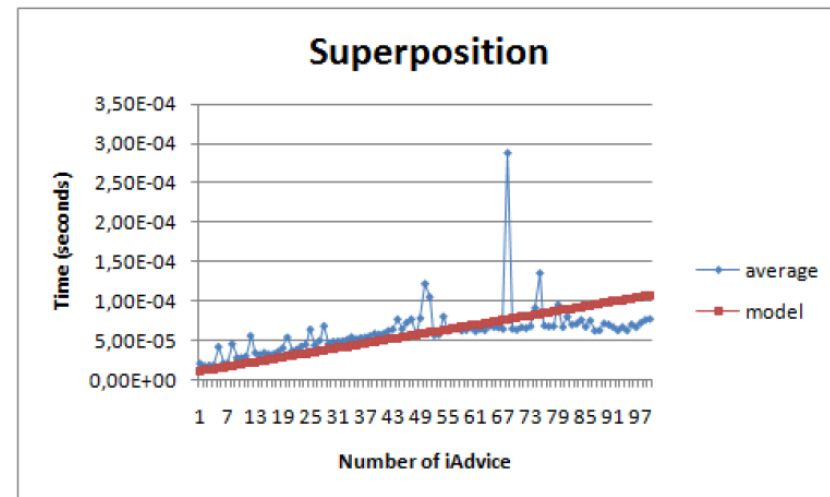

Conflict Resolution, Example with ISL4WComp

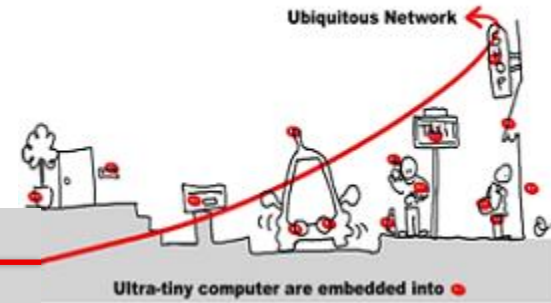

- Duration of instance of advice merging

F : duration of instance of advice merging

g_0 : number of rules in the base assembly

y : number of instance of advice

w : number of advice rule

a_1 : model parameters

p_i : merging probability

M : Cost of merging

$$F = a_1.g_0 \times \sum_{i=1}^y w_i.p_i.M$$

Conflict Resolution, Example with ISL4WComp

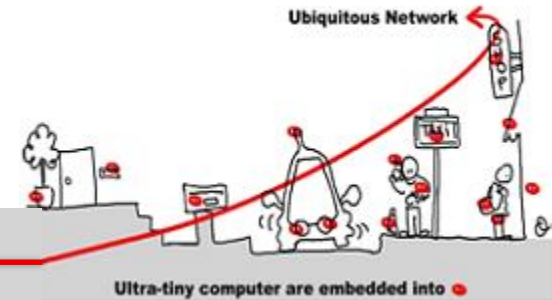

- Conflict resolution processing response time.
- Experiments : Response time average with C=33% and 50%

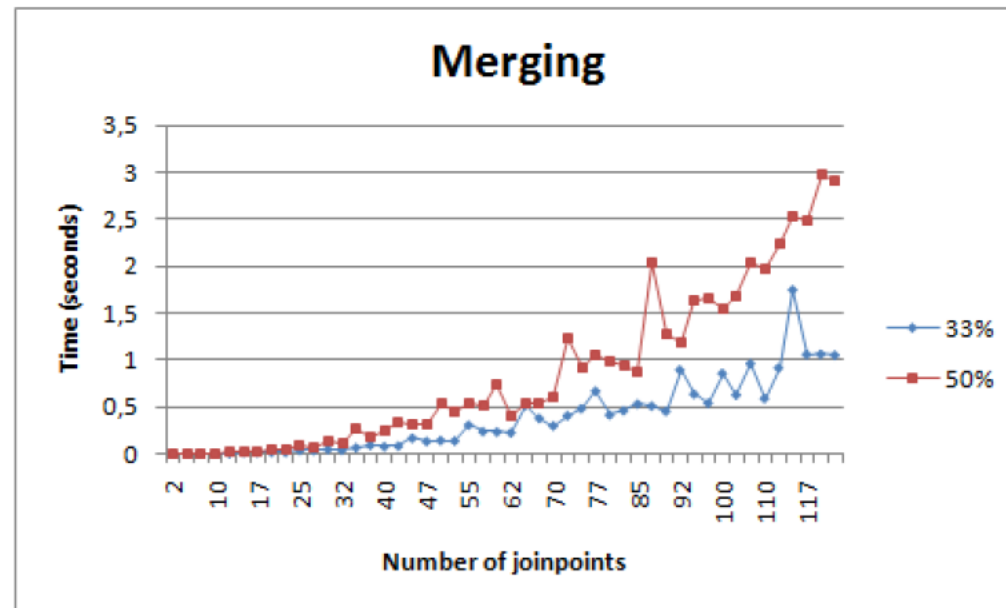

Synthesis : Overall Weaving Cycle

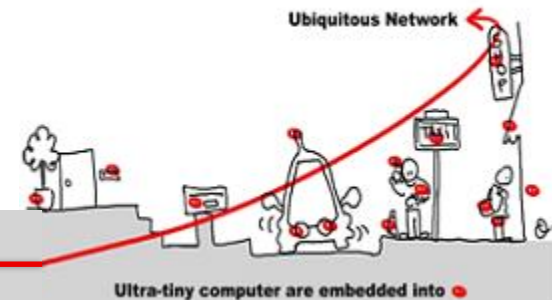

- Weaving cycles duration can be formally define as follows : $W(n) = D(n)+C(n)+A(n)+S(n)+F(n)$ where n is the set of joinpoints from the base assembly.

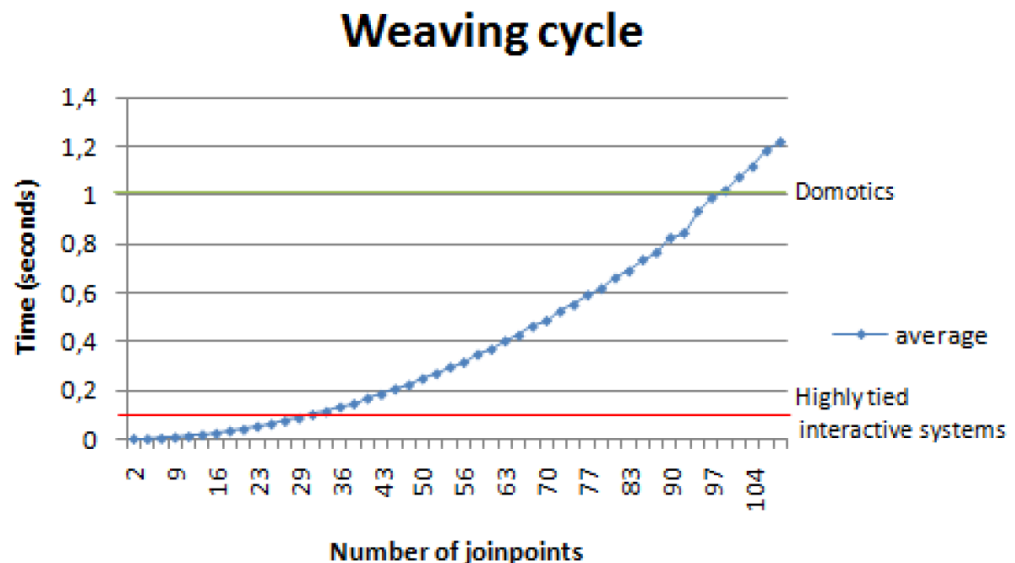

DEMO and future works

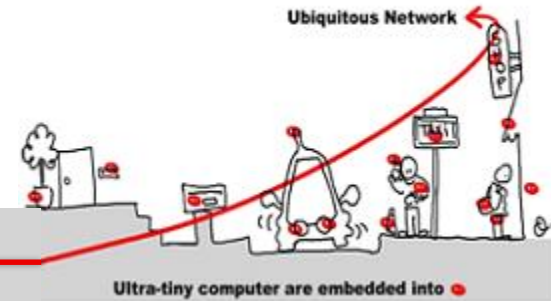

- Simple Demo : AA in WComp
- Other DEMO : AA in WComp

Future Works in WComp

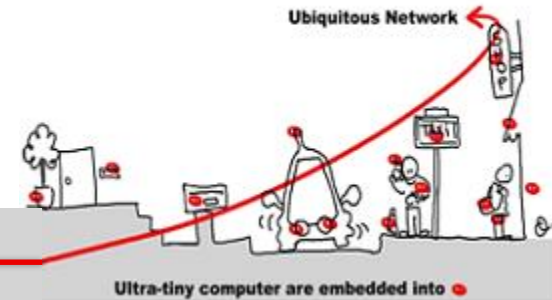

- **Multi-Domain** weaving for AA to adapt Mobile Workers applications (Cf. CONTINUUM project of the French National Research Agency towards « Continuity of Service »)
- Adaptation triggered by **physical environment** variations
- **Semantic adaptation** : Improving of Pointcut Matching algorithms from Ontology-Based Metadata and mapping between ontologies (Cf. Continuum project of the French National Research Agency towards « Continuity of Service »)

7.4 Questions ?

